

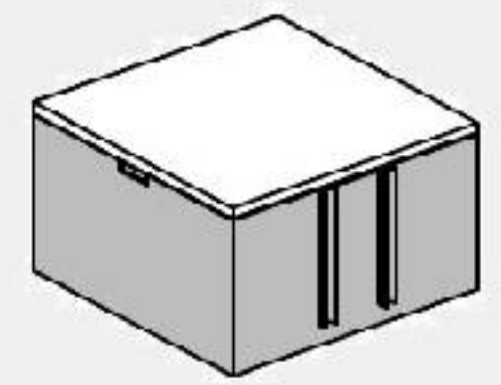



























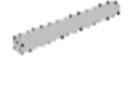















Bauanleitung
Kistenschieber



Kistenschieber

Einzelteilübersicht

	32985		32293		35049
Grundplatte 258x188	1	Mini Motor 6-9V=; 0,65A max	2	Baustein 15x30x5 mit Nut und	4
	32881		31078		36293
Baustein 15 schwarz	21	U-Getriebe	1	Winkelträger 120, schwarz	12
	32882		31082		32850
Baustein 15 mit 2 Zapfen	9	Rastachse mit Zahnrad Z28,	1	Riegelstein 15x15	54
	31232		35945		38249
Aluprofil 390	2	Rast-Ritzel Z10, m=1,5	1	Bauplatte 30x80, rot	12
	31555		36248		38251
Flachstein 80, rot	13	Rastkettenglied rot	419	Bauplatte 30x90, rot	14
	31011		32879		38259
Winkelstein 30 Grad	4	Baustein 30 schwarz	17	Bauplatte 30x30	4
	31031		38423		37237
Metallachse 110	2	Winkelstein 10x15x15	3	Baustein 5	2
	35695		32698		38248
Zahnrad Z15	4	Fotowiderstand LDR03	1	Bauplatte 30x45, rot	2
	35031		36532		37783
Flachnabenzange	1	Störlichtkappe, Öffnung 8	2	Mini-Taster	2
	31021		38216		38464
Zahnrad Z20	1	Leuchtstein mit Steckfassung	1	Bauplatte 15x80 rot	2
	31058		37875		37272
Nabenmutter mit Scheibe	1	Linsenstecklampe 9V= 0,1A	1	Zahnstangengetriebe m=0,5	1
	37238		35969		31224
Baustein 5 mit 2 Zapfen	8	Reedkontakt- und Kabelhalter	7	Aluprofil 105	1

 Aluprofil 55	31119 1
 Zahnstange 80	37351 2
 Zahnstange 30	37457 1
 Bauplatte 15x30x5 mit 3 Nuten	38428 1
 Baustein 15 grau	31005 1
 V-Bauplatte 90x15, rot	31512 1
 Bauplatte 15x30, rot	38241 2

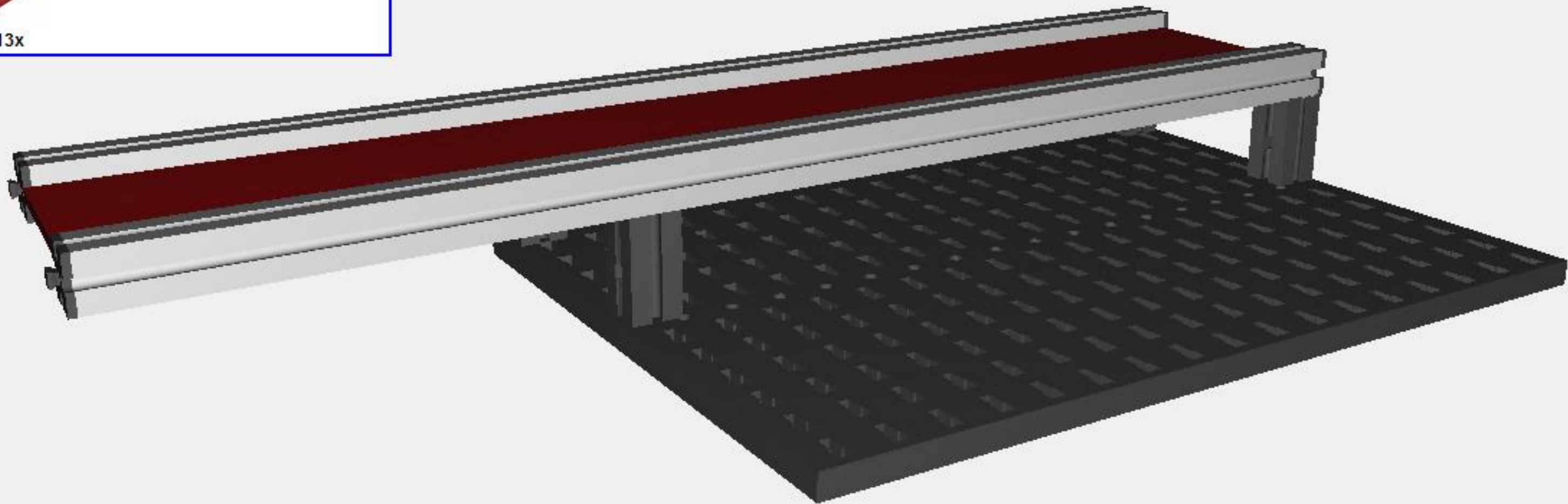
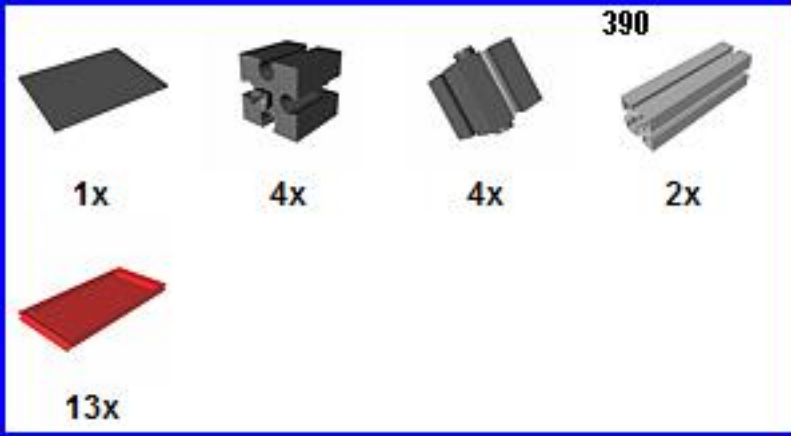

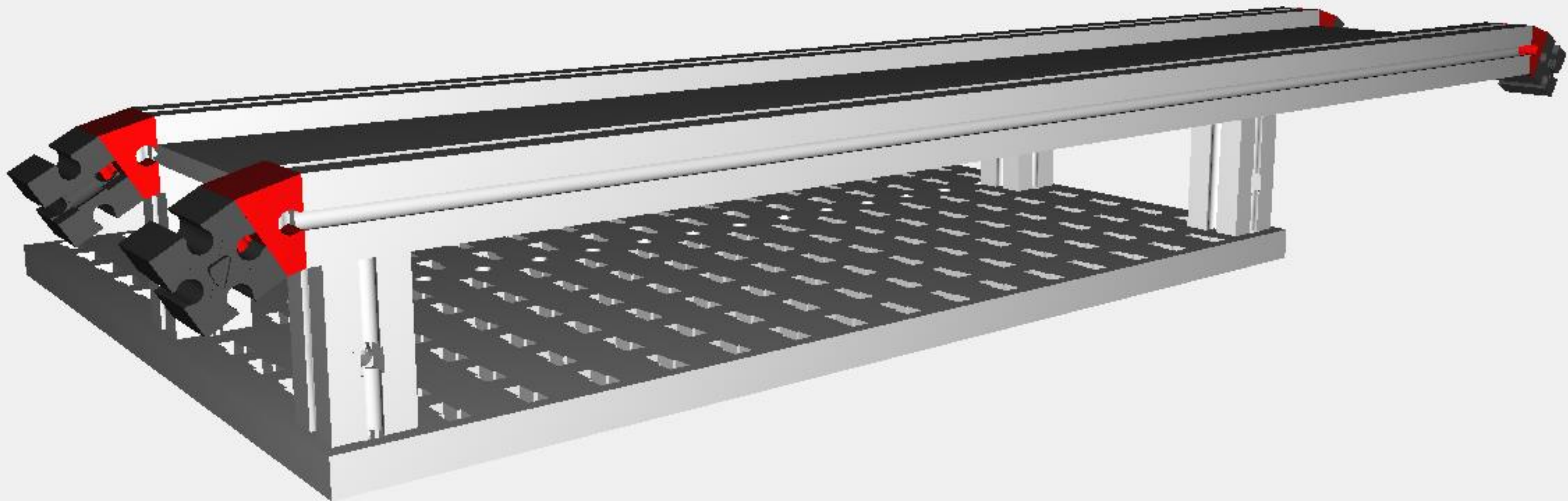
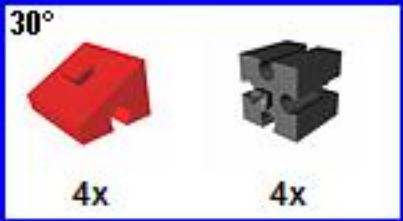







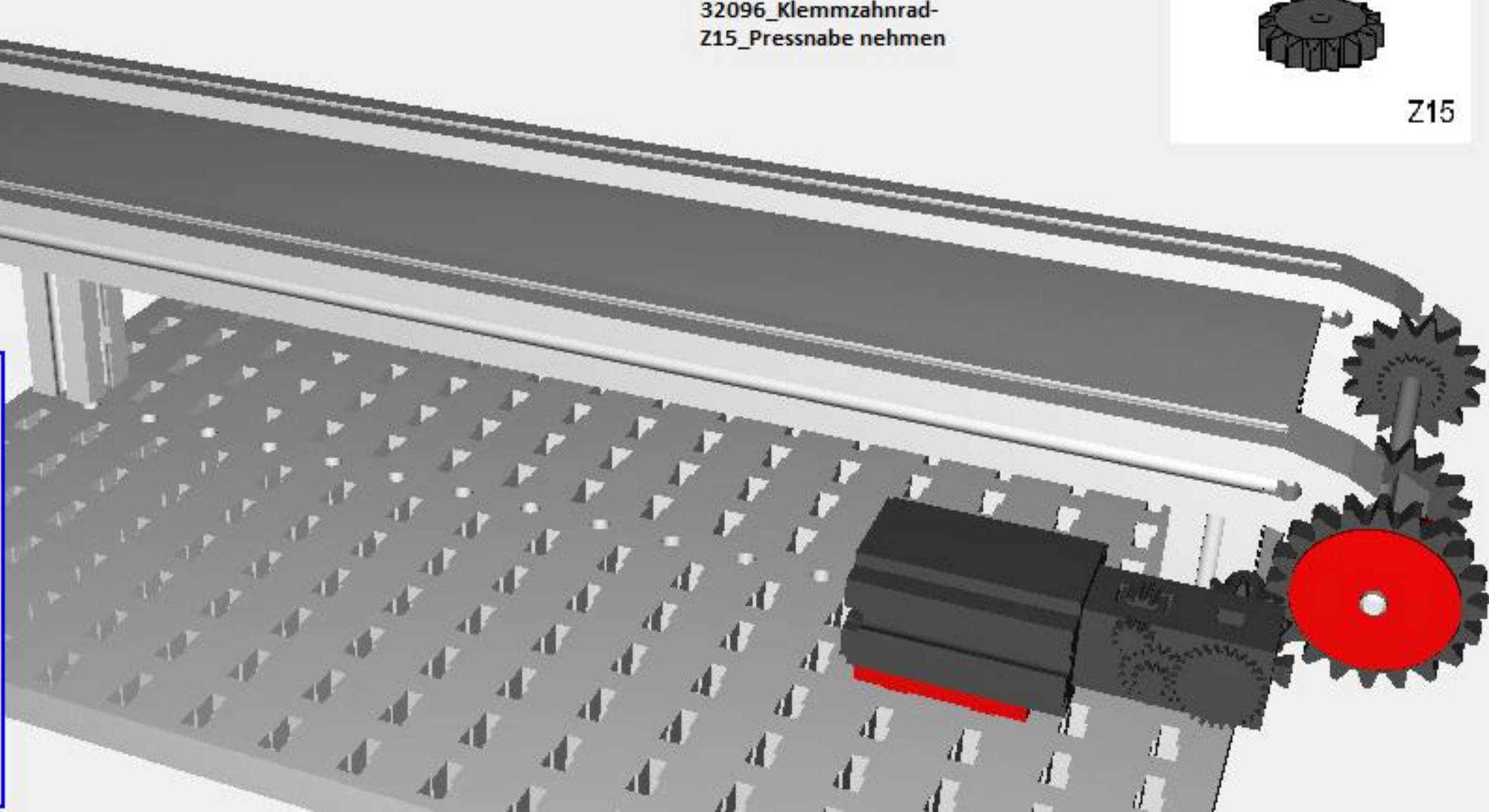
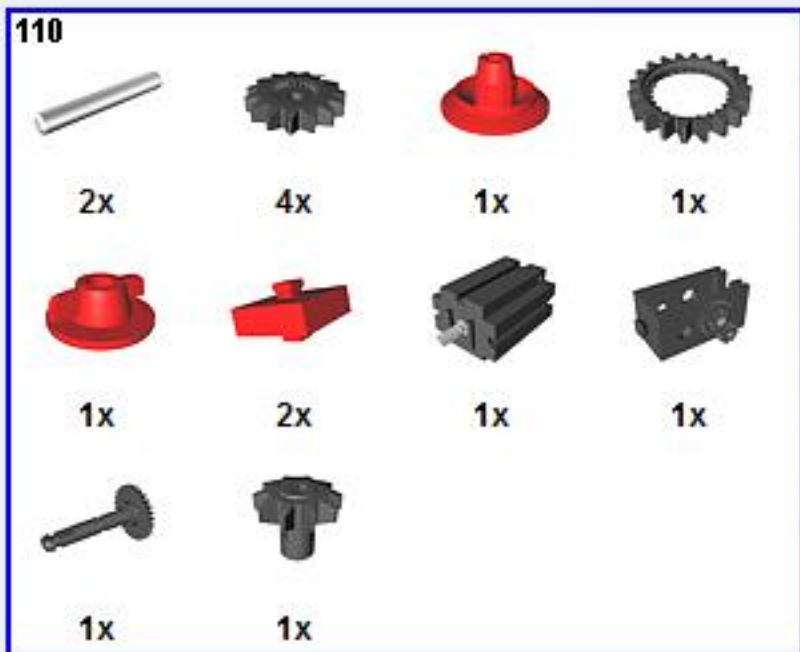

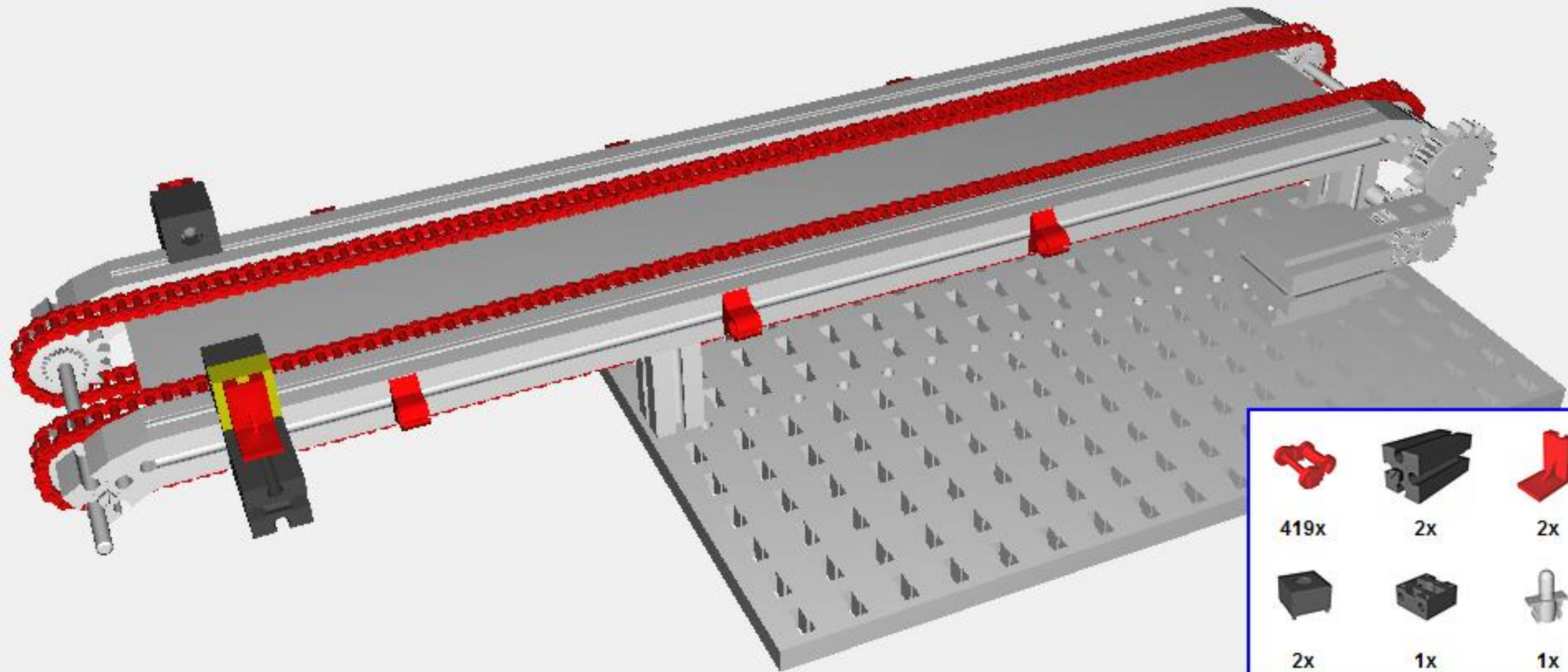
32096_Klemmzahnrad-
Z15_Pressnabe nehmen



Z15





			
419x	2x	2x	1x
			
2x	1x	1x	6x

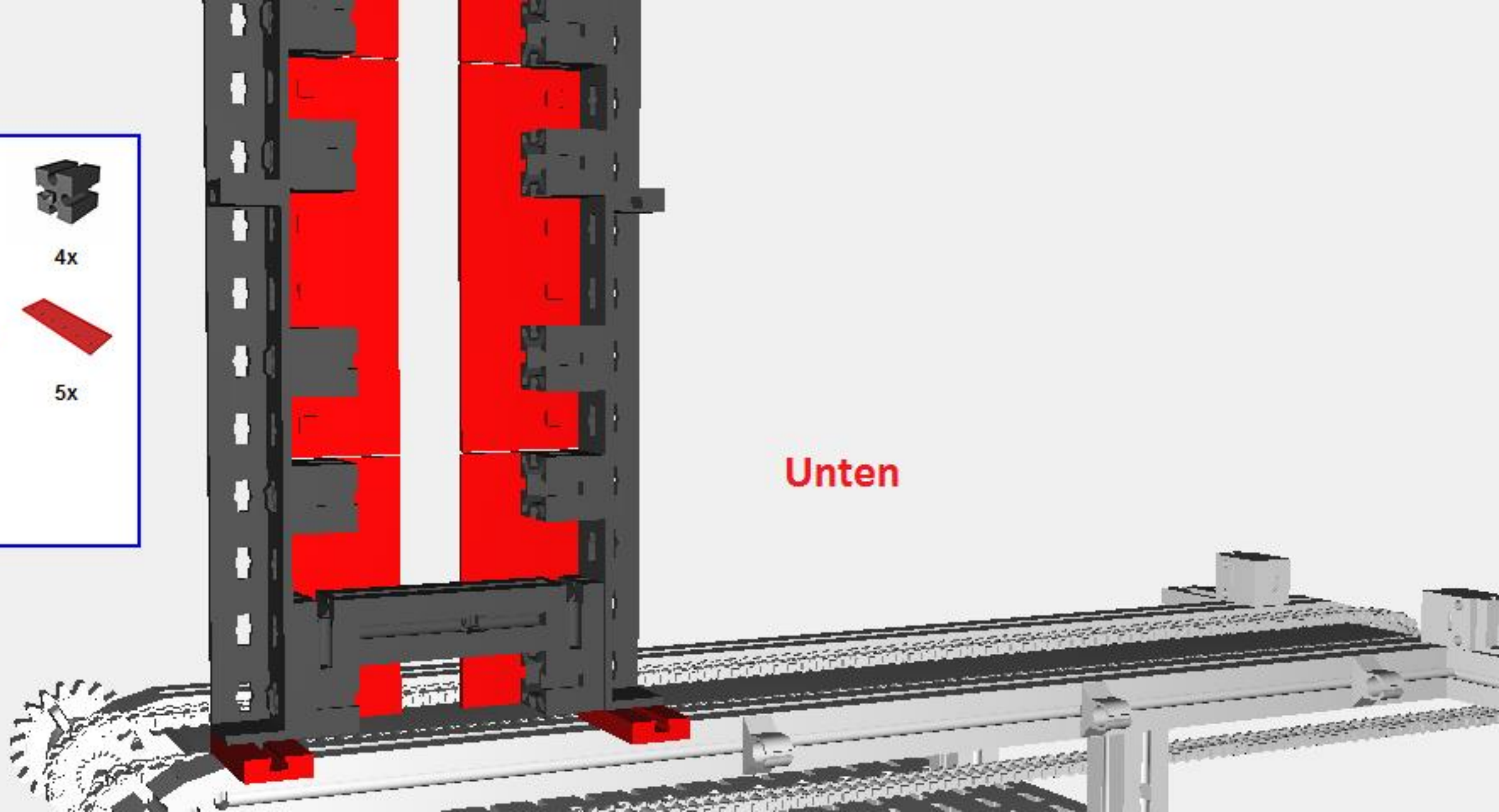
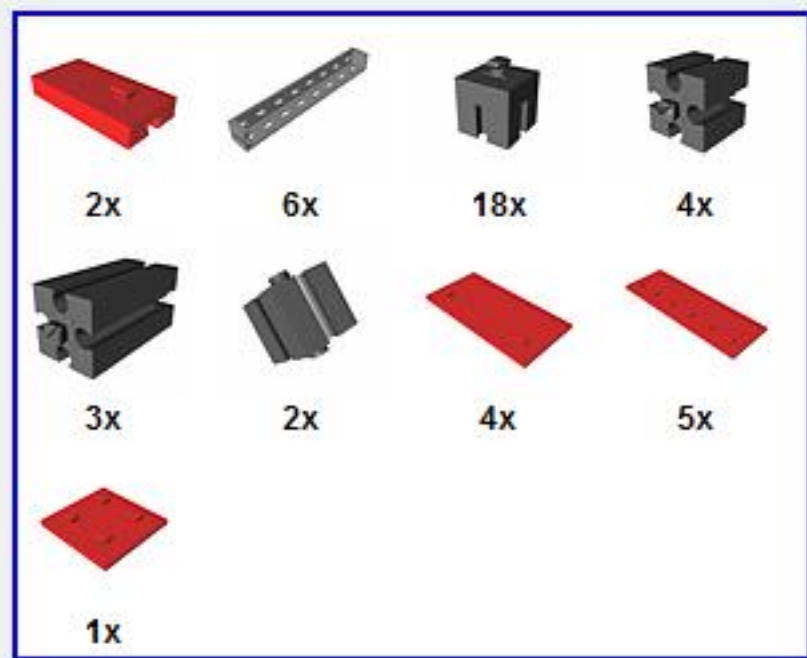

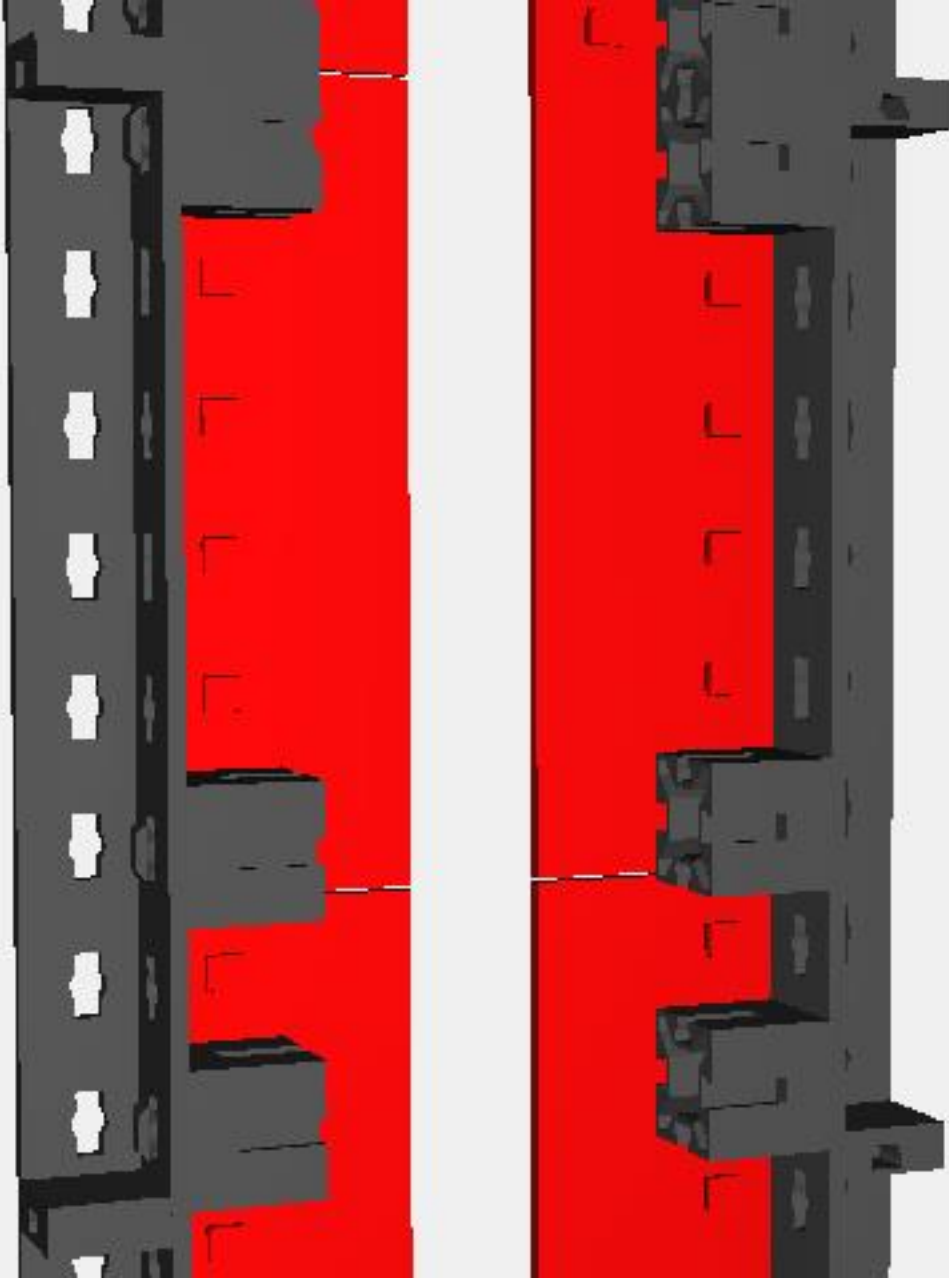

Mitte

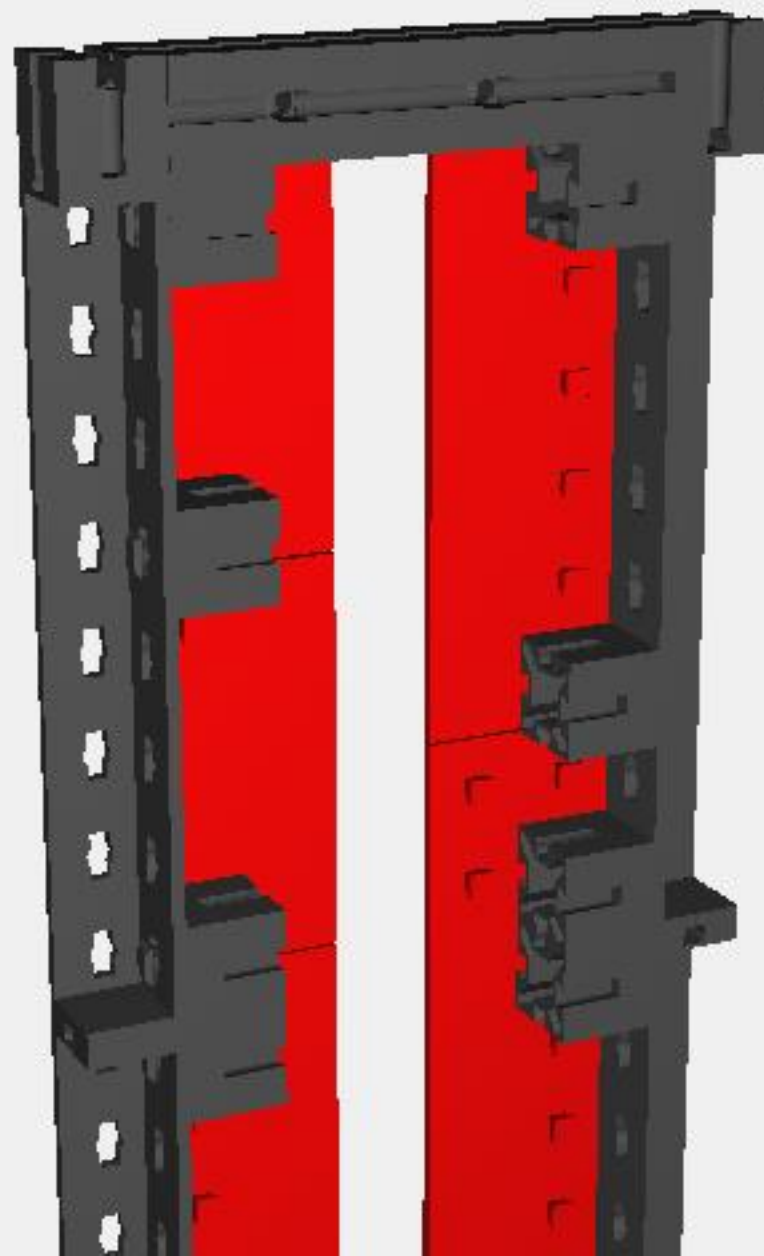

Oben

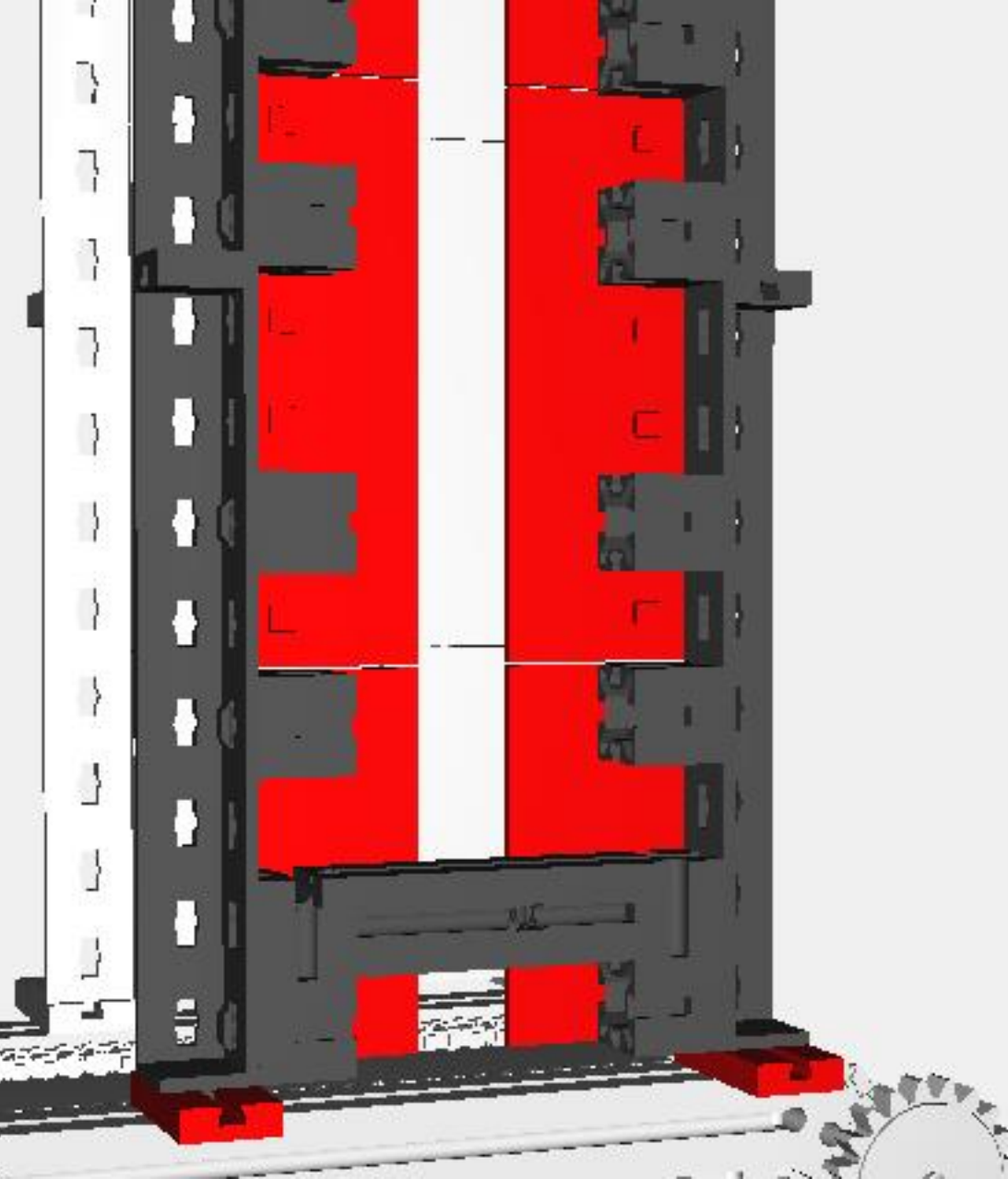
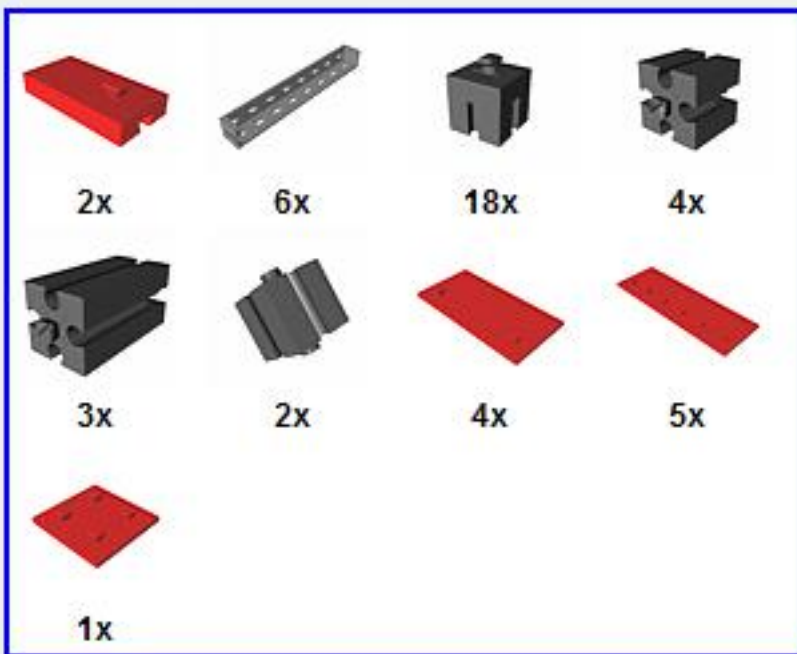

Motorseite Unten

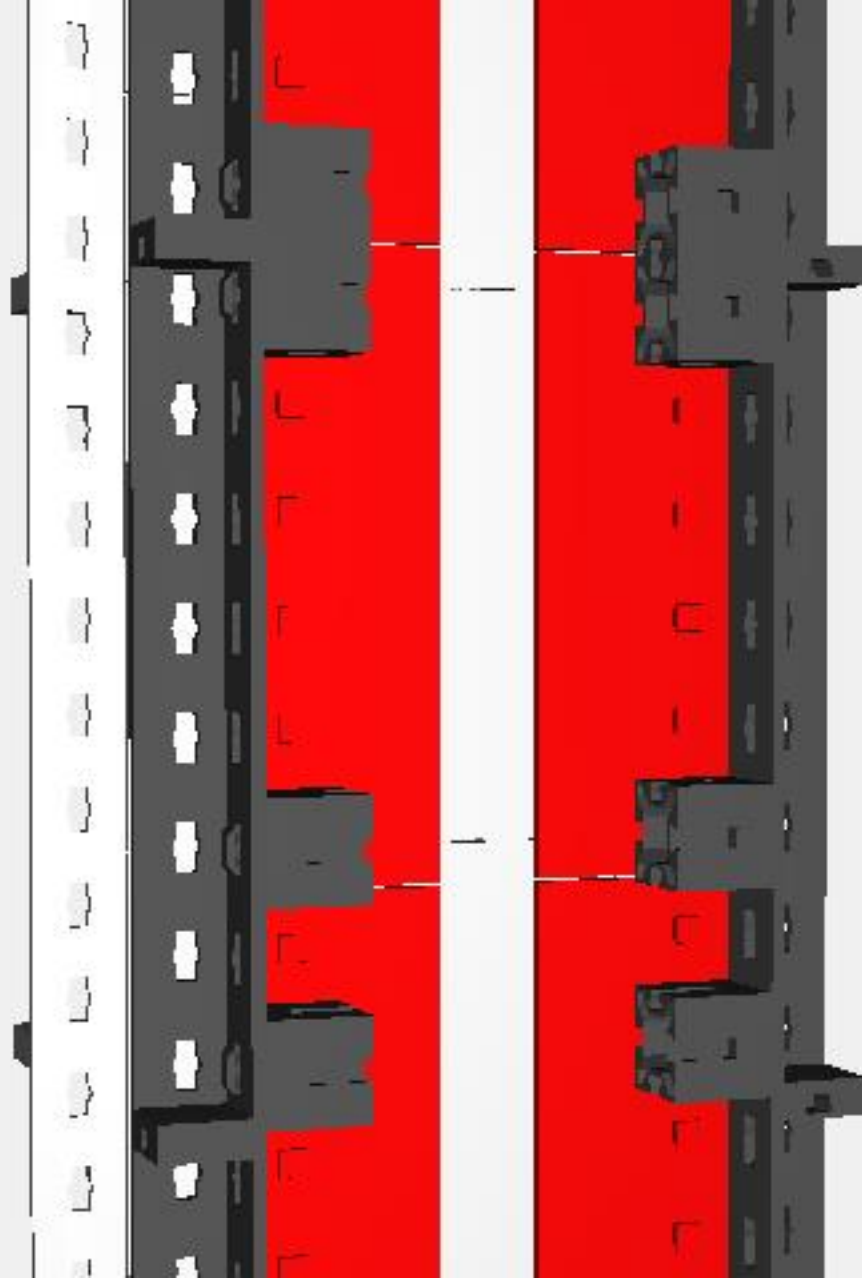

Motorseite Mitte

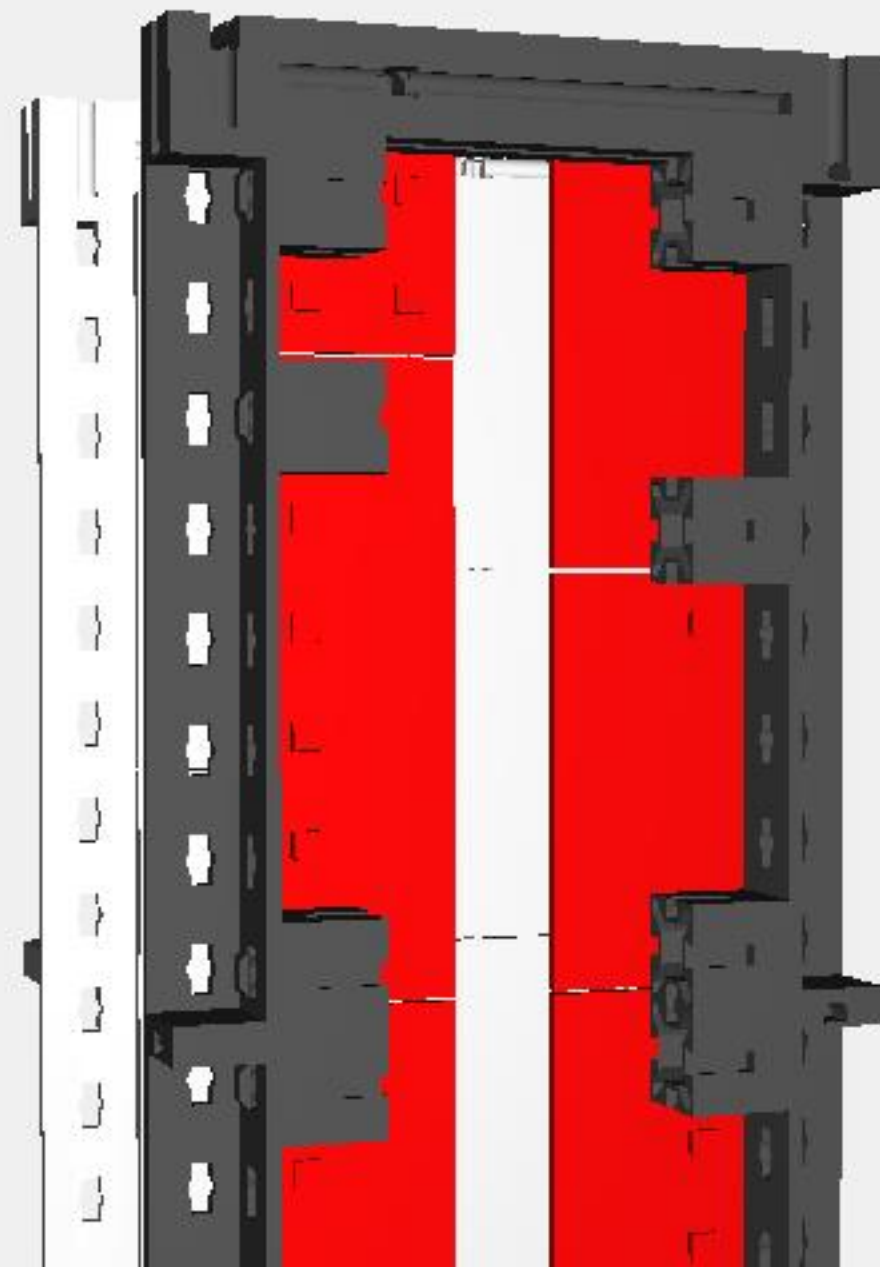

Motorseite Oben

Vorne Unten

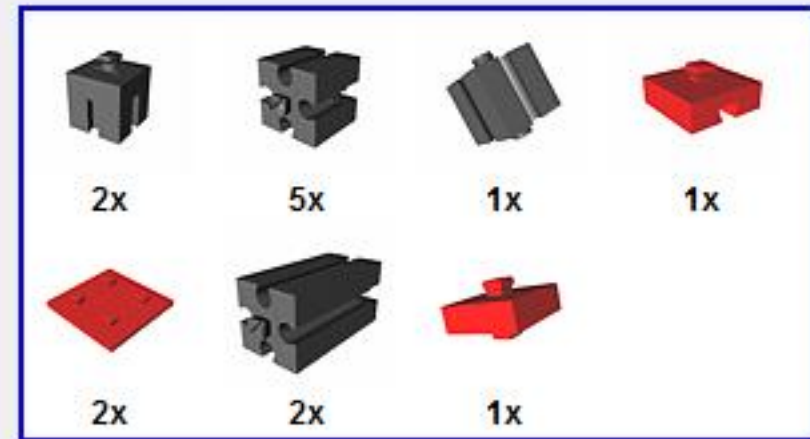
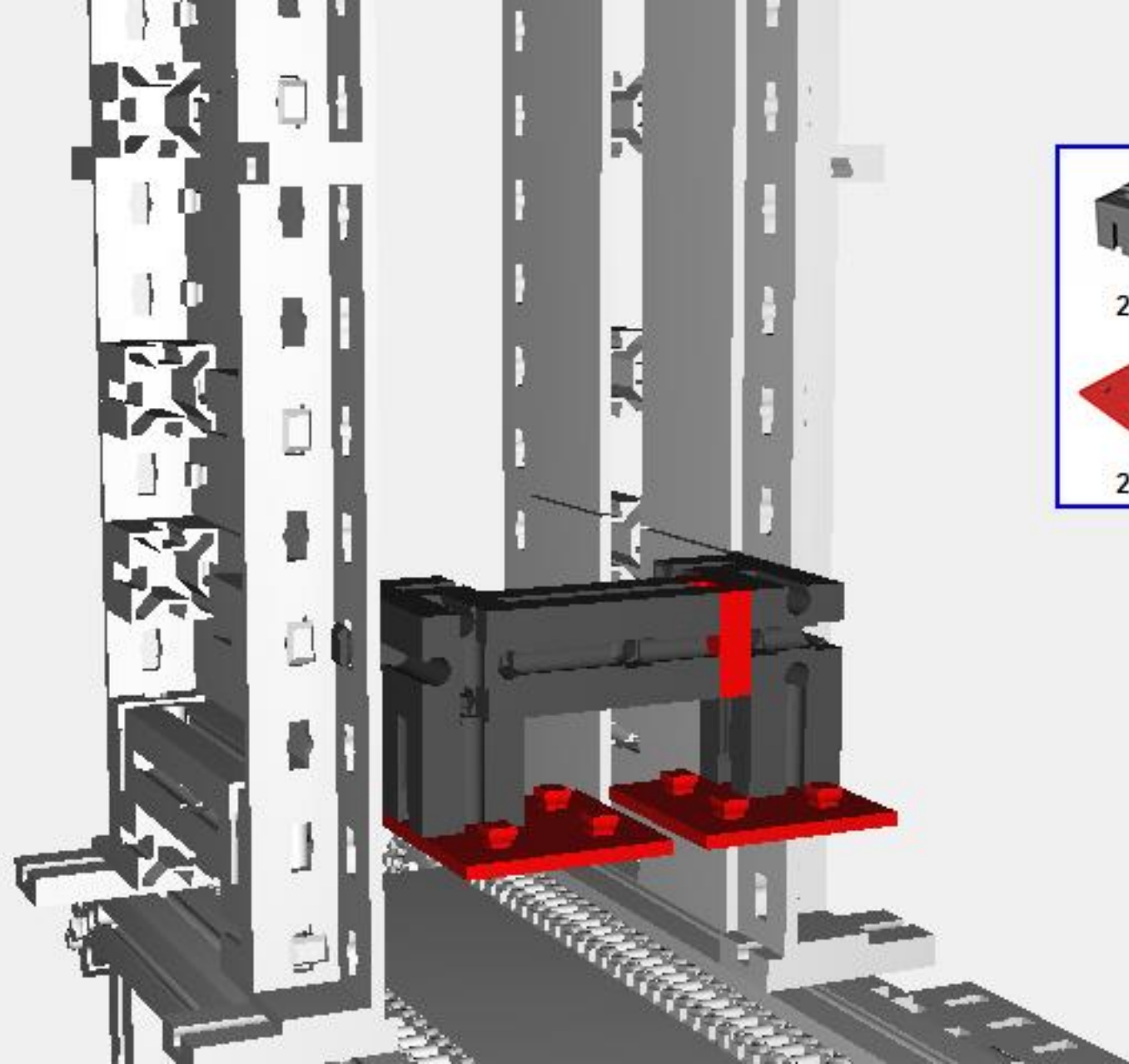

Vorne Oben

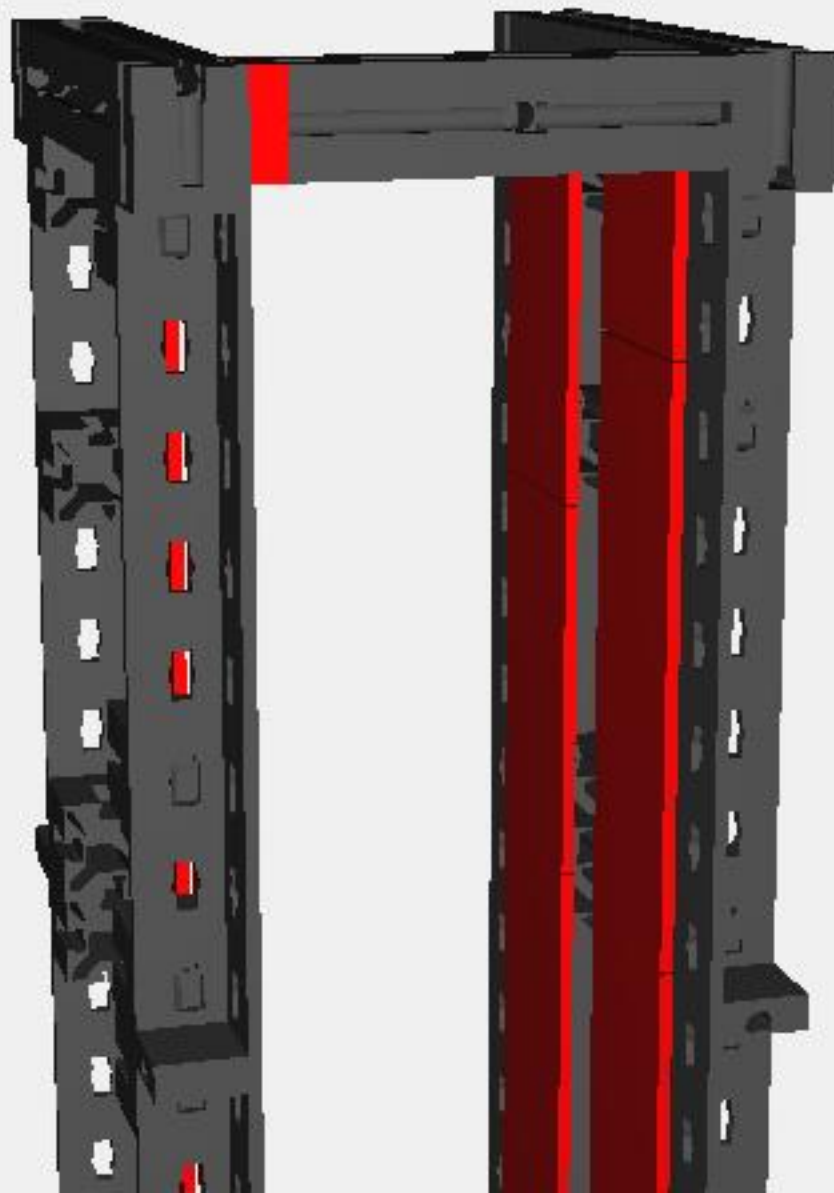

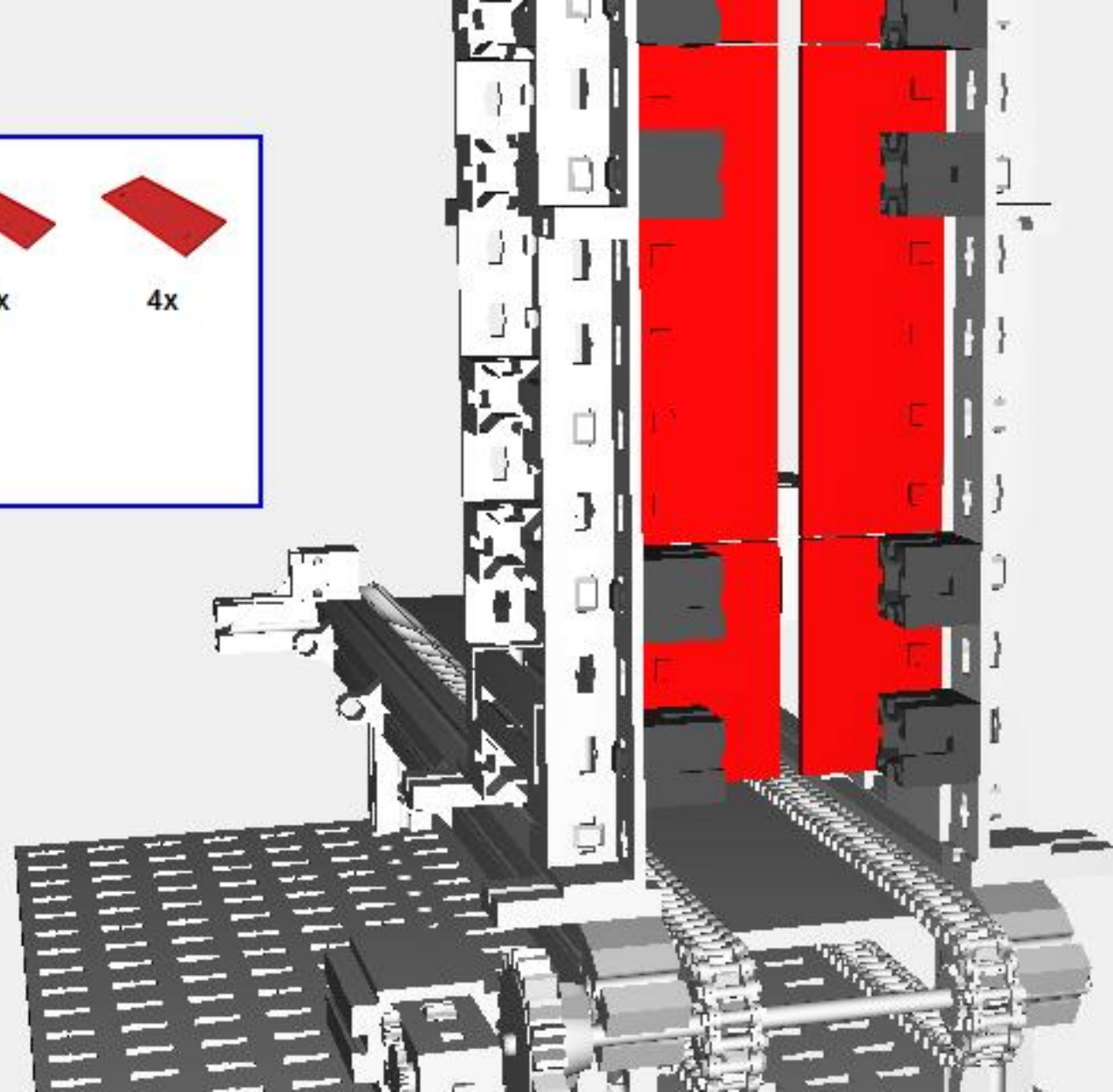
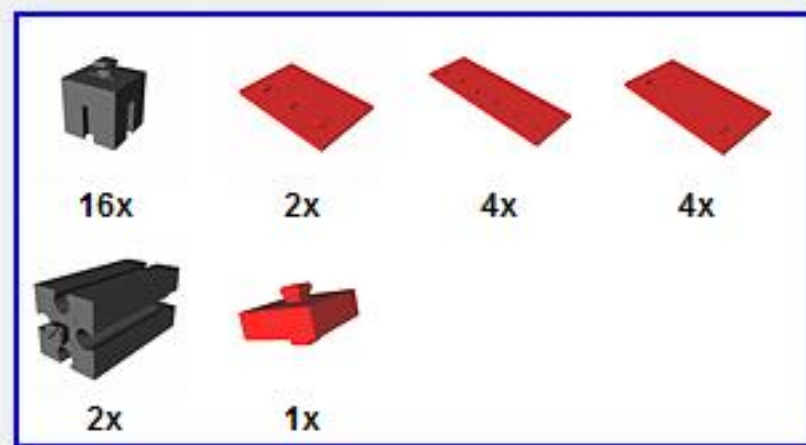

Hinten Unten

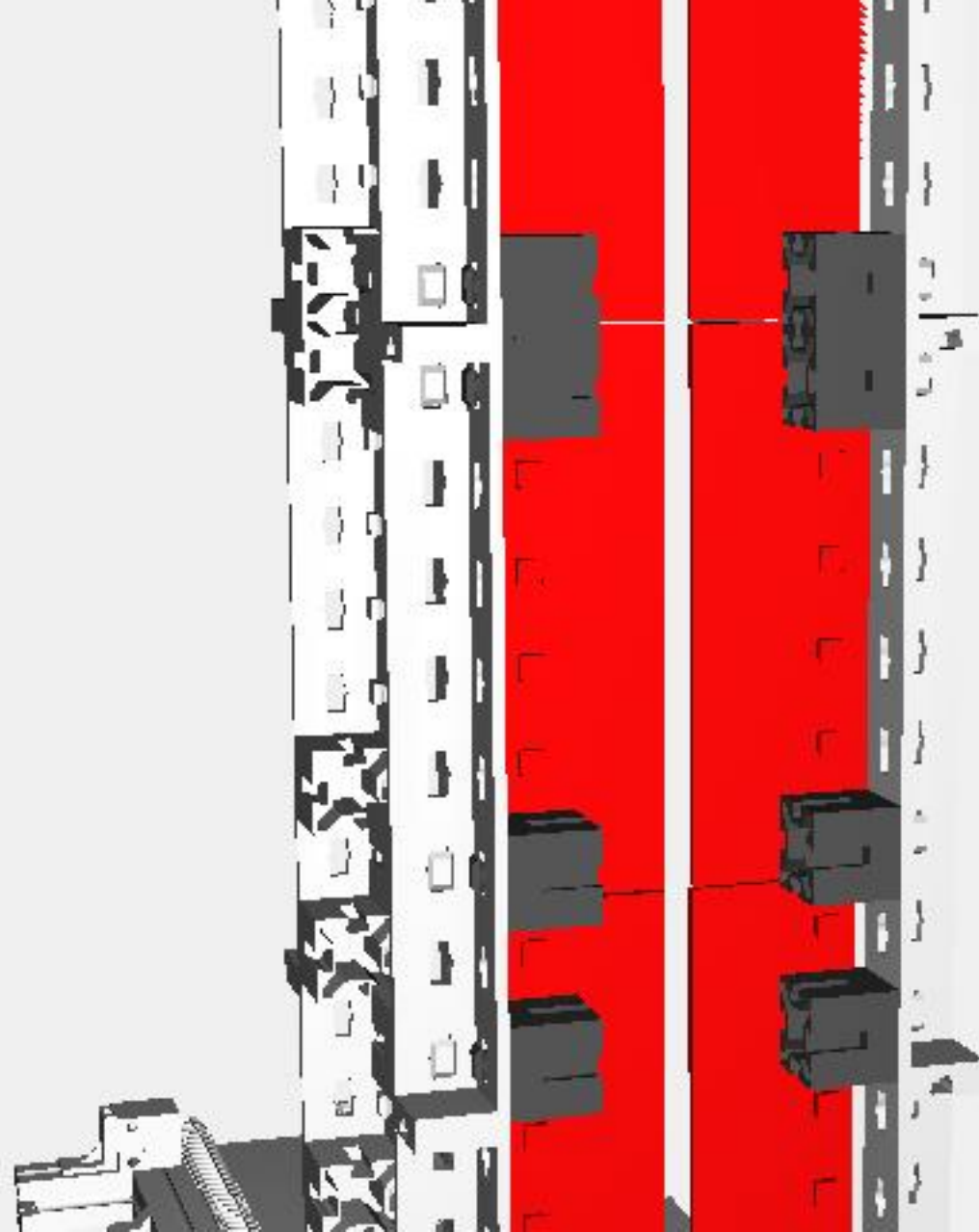

Hinten Mitte

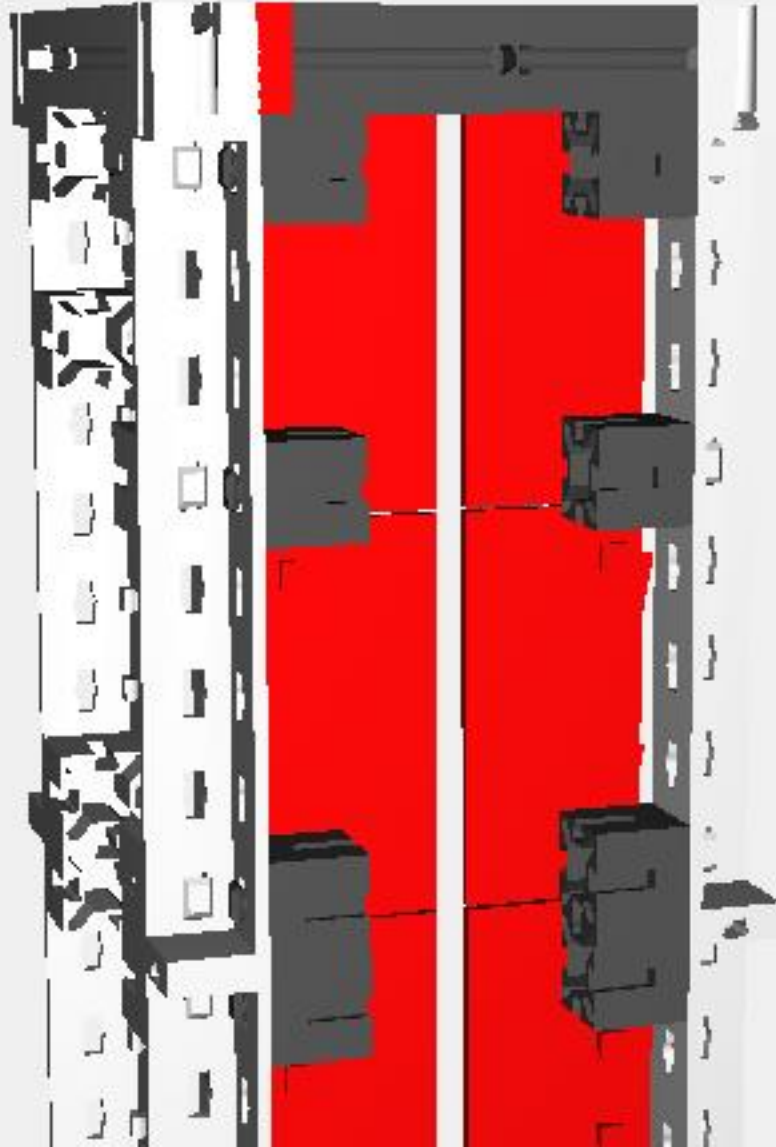

Hinten Oben

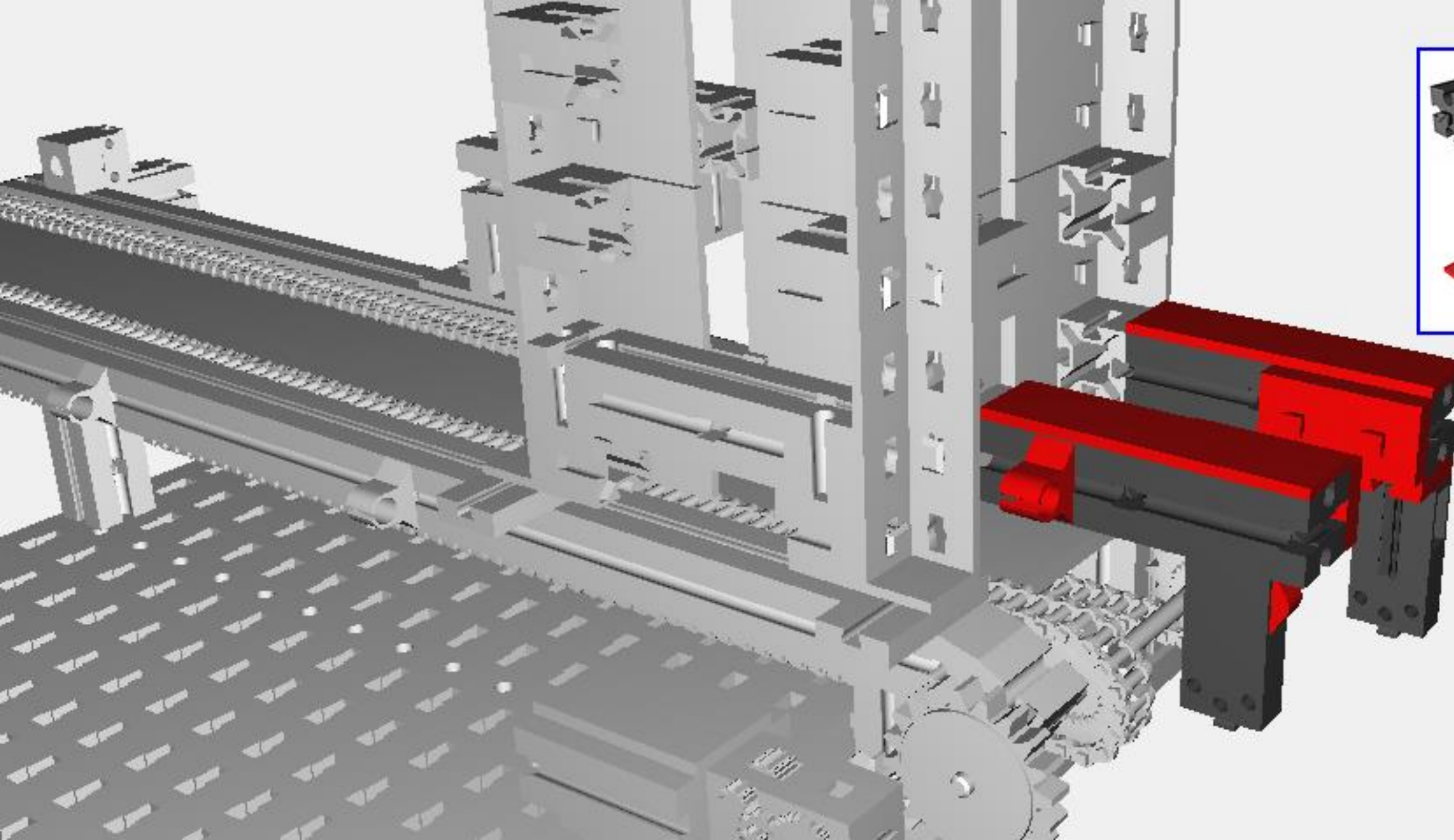

- | | | | |
|----|----|----|----|
| | | | |
| 4x | 4x | 2x | 1x |
| | | | |
| 1x | 1x | 2x | |

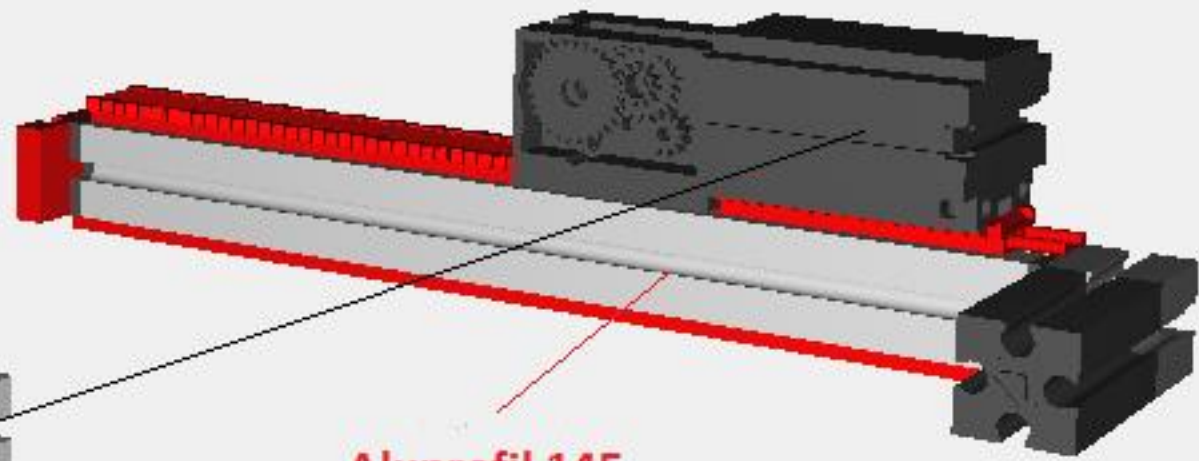
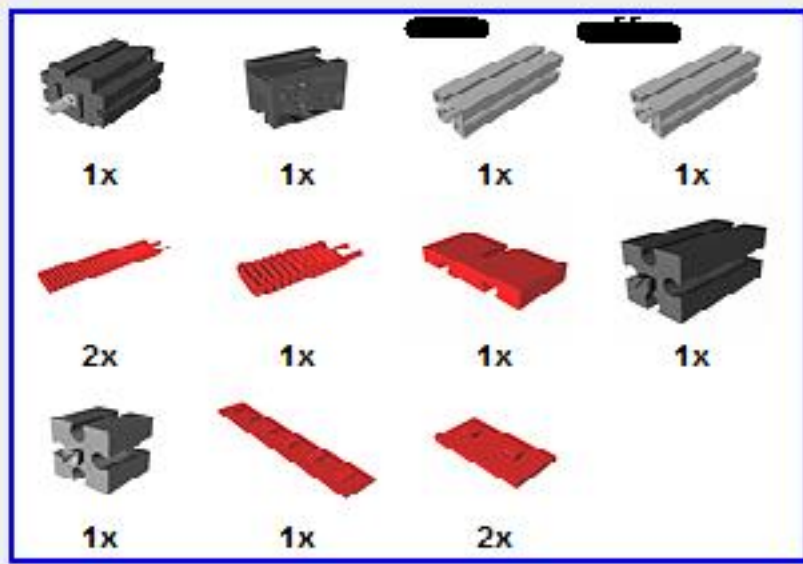
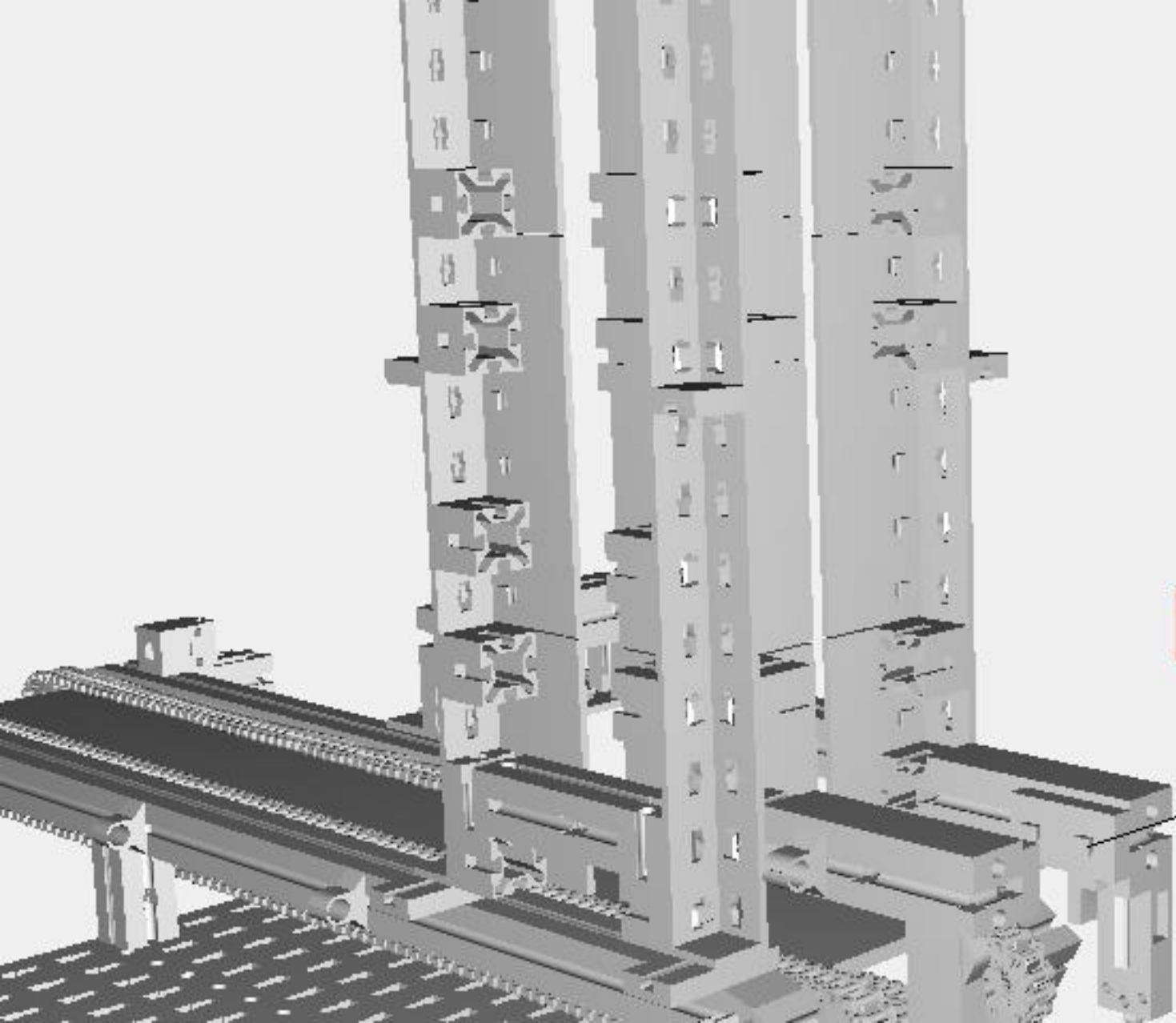

Aluprofil 145



Kistenschieber

Preisberechnung

Artikel-Nr.	Bezeichnung	Einzelpreis	Anzahl	Gesamtpreis
32985	Grundplatte 258x186	1,95	1	1,95
32881	Baustein 15 schwarz	0,65	21	13,65
32882	Baustein 15 mit 2 Zapfen	0,70	9	6,30
31232	Aluprofil 390	-,--	2	-,--
31555	Flachstein 60, rot	0,80	13	10,40
31011	Winkelstein 30 Grad	0,40	4	1,60
31031	Metallachse 110	1,50	2	3,00
35695	Zahnrad Z15	0,45	4	1,80
35031	Flachnabenzange	0,45	1	0,45
31021	Zahnrad Z20	0,40	1	0,40
31058	Nabenmutter mit Scheibe	0,30	1	0,30
37238	Baustein 5 mit 2 Zapfen	0,35	8	2,80
32293	Mini Motor 6-9V=; 0,65A max	20,60	2	41,20
31078	U-Getriebe	3,40	1	3,40
31082	Rastachse mit Zahnrad Z28, m=0,5	0,80	1	0,80
35945	Rast-Ritzel Z10, m=1,5	0,40	1	0,40
36248	Rastkettenglied rot	0,15	419	62,85
32879	Baustein 30 schwarz	0,80	17	13,60
38423	Winkelstein 10x15x15	0,30	3	0,90
32698	Fotowiderstand LDR03	10,95	1	10,95
36532	Störlichtkappe, Öffnung 6	0,20	2	0,40
38216	Leuchtstein mit Steckfassung	1,35	1	1,35
37875	Linsenstecklampe 9V= 0,1A	2,00	1	2,00
35969	Reedkontakt- und Kabelhalter	0,35	7	2,45
35049	Baustein 15x30x5 mit Nut und Zapfen	0,70	4	2,80
36293	Winkelträger 120, schwarz	1,10	12	13,20
32850	Riegelstein 15x15	0,50	54	27,00
38249	Bauplatte 30x60, rot	0,75	12	9,00
38251	Bauplatte 30x90, rot	1,05	14	14,70
38259	Bauplatte 30x30	0,55	4	2,20
37237	Baustein 5	0,35	2	0,70
38248	Bauplatte 30x45, rot	0,60	2	1,20
37783	Mini-Taster	4,15	2	8,30
38464	Bauplatte 15x60 rot	0,50	2	1,00
37272	Zahnstangengetriebe m=0,5	7,45	1	7,45
31224	Aluprofil 105	-,--	1	-,--
31119	Aluprofil 55	-,--	1	-,--

37351	Zahnstange 60	1,45	2	2,90
37457	Zahnstange 30	1,15	1	1,15
38428	Bauplatte 15x30x5 mit 3 Nuten	0,75	1	0,75
31005	Baustein 15 grau	0,65	1	0,65
31512	V-Bauplatte 90x15, rot	-,--	1	-,--
38241	Bauplatte 15x30, rot	0,35	2	0,70
			642	276,65

Kistenschieber

