

ft:c

Adventskalender 2012
Bauanleitung

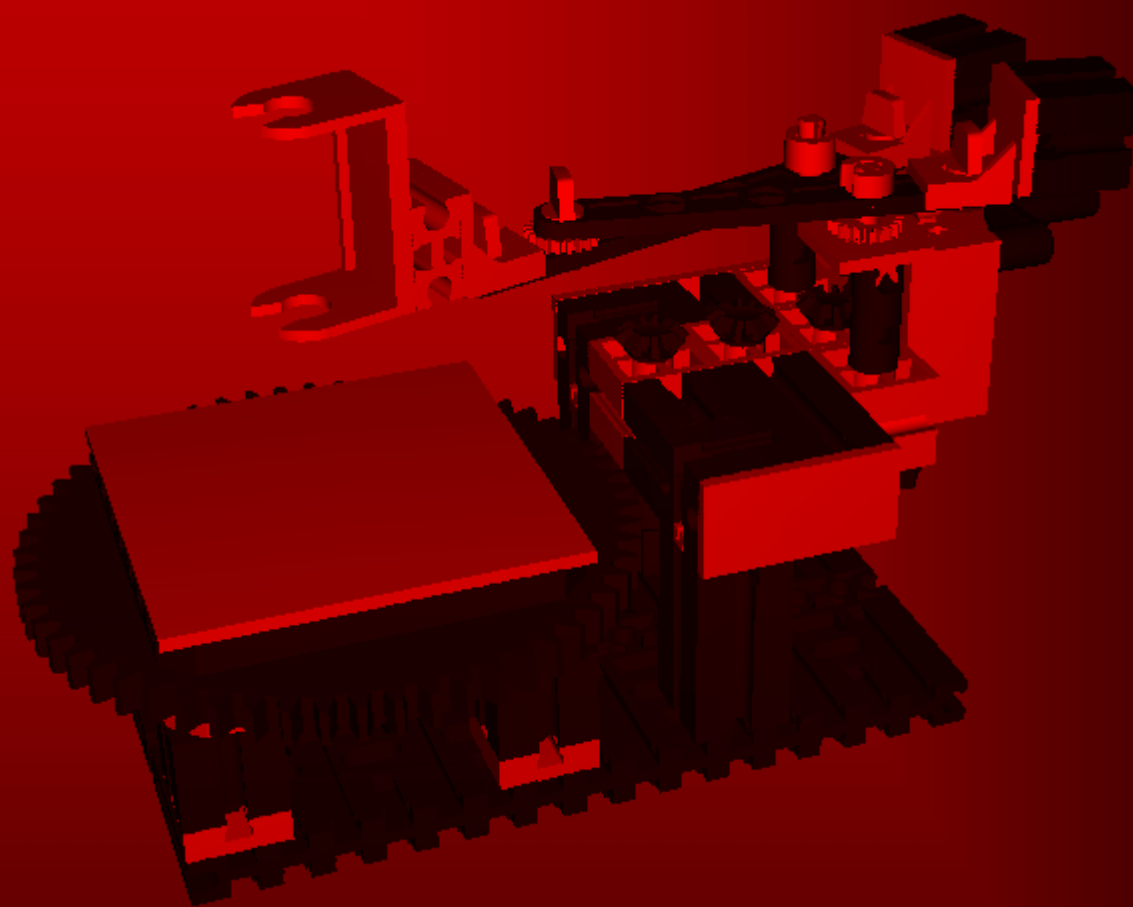























Mini-Malmaschine







von Frank Jakob

ftdesigner Datei von Andreas Gürten

Einzelteilübersicht

	35129
Grundplatte 120x60	1
	37237
Baustein 5	4
	32882
Baustein 15 mit 2 Zapfen	4
	31391
Drehkranz-Unterteil	1
	31390
Drehkranz Oberteil	1
	32879
Baustein 30 schwarz	3
	38249
Bauplatte 30x60, rot	2
	31982
Federnocken	4
	32881
Baustein 15 schwarz	7
	32064
Baustein 15 mit Bohrung	6
	38242
Bauplatte 15x45, rot	1
	38241
Bauplatte 15x30, rot	1

	35063
Rastachse 30	2
	35061
Rastachse mit Kegelzahnrad	4
	35945
Rast-Ritzel Z10, m=1,5	5
	38423
Winkelstein 10x15x15	1
	32330
Bauplatte 15x30x3,75 mit Nut	1
	35088
Gelenkkurbel	1
	36819
Lagerhülse	1
	36227
Rastadapter	2
	31124
Aufnahmeachse	2
	36923
I-Strebe 75 mit Loch, schwarz	1
	36334
Riegelscheibe	2
	36324
S-Riegel 6 rot	1

	36323
S-Riegel 4 rot	3
	31674
Adapterlasche	3
	37679
Klemmbuchse 5	2
	36952
I-Strebe 60 mit Loch, schwarz	1
	37468
Baustein 7,5	1
	35069
Seilwinden-Gestell 30	1

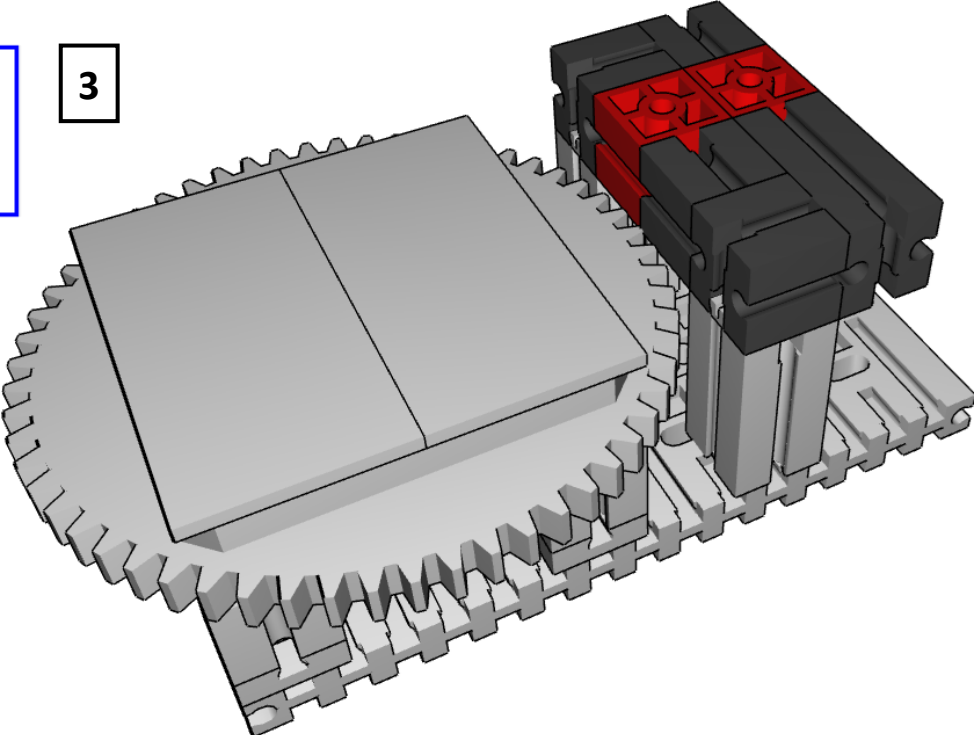
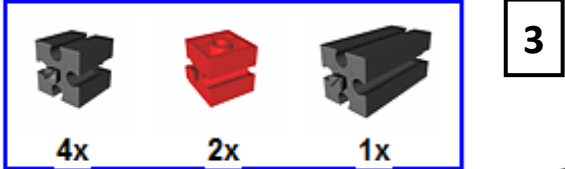
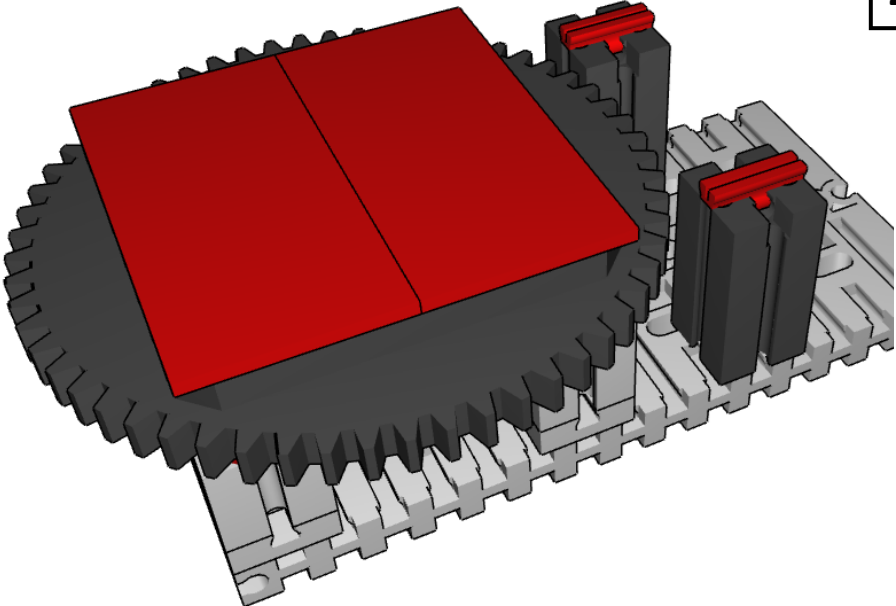
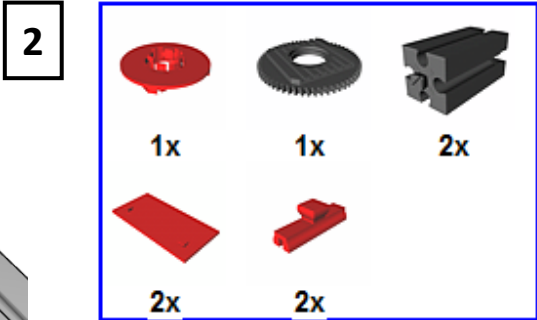
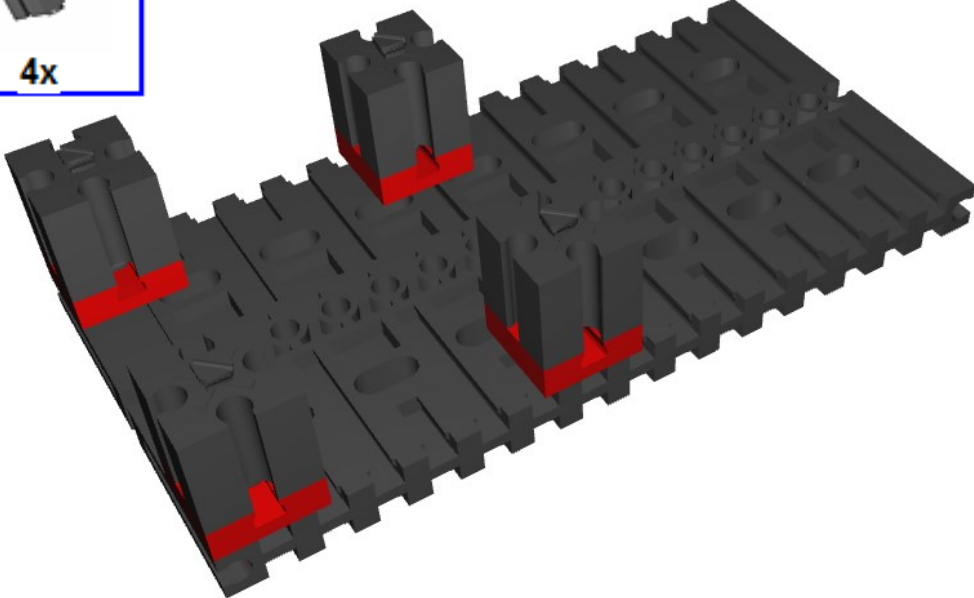
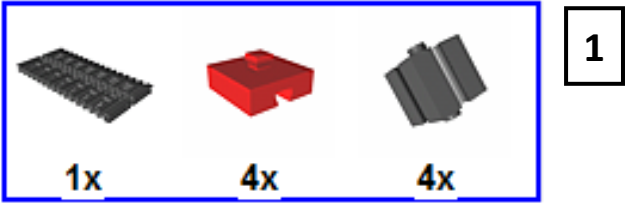

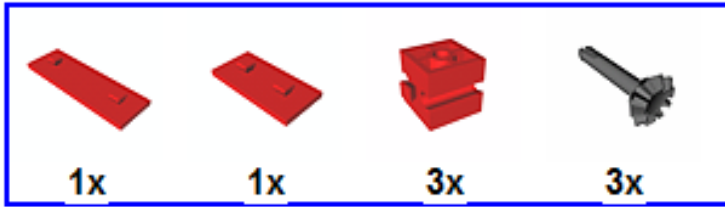

4

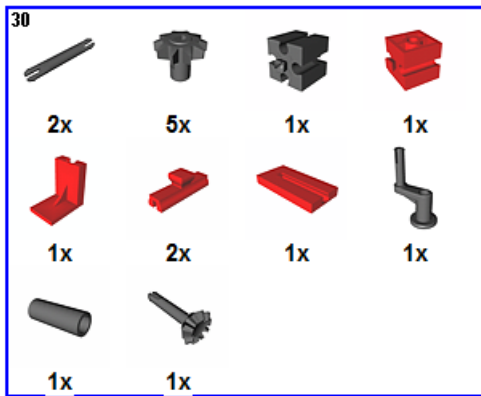
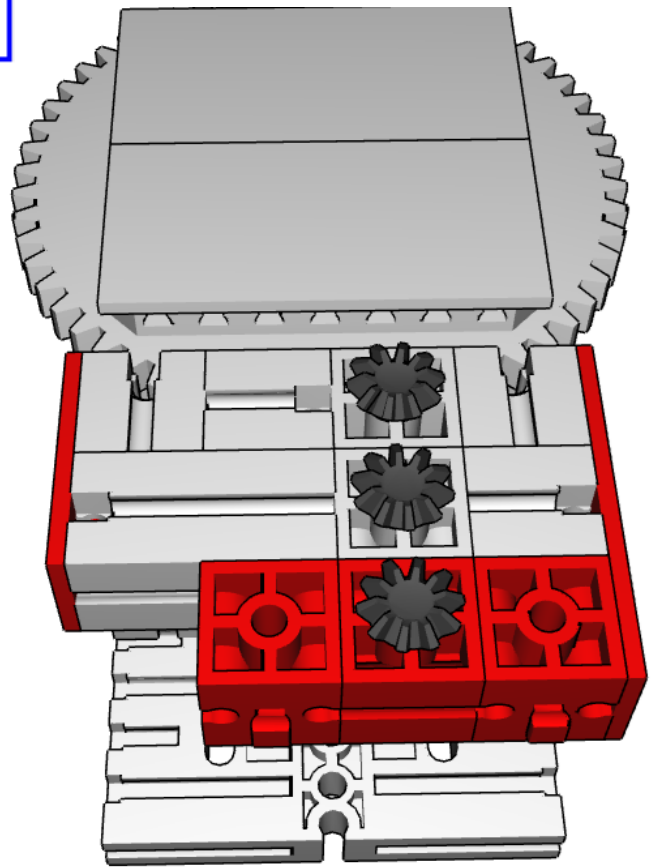

5

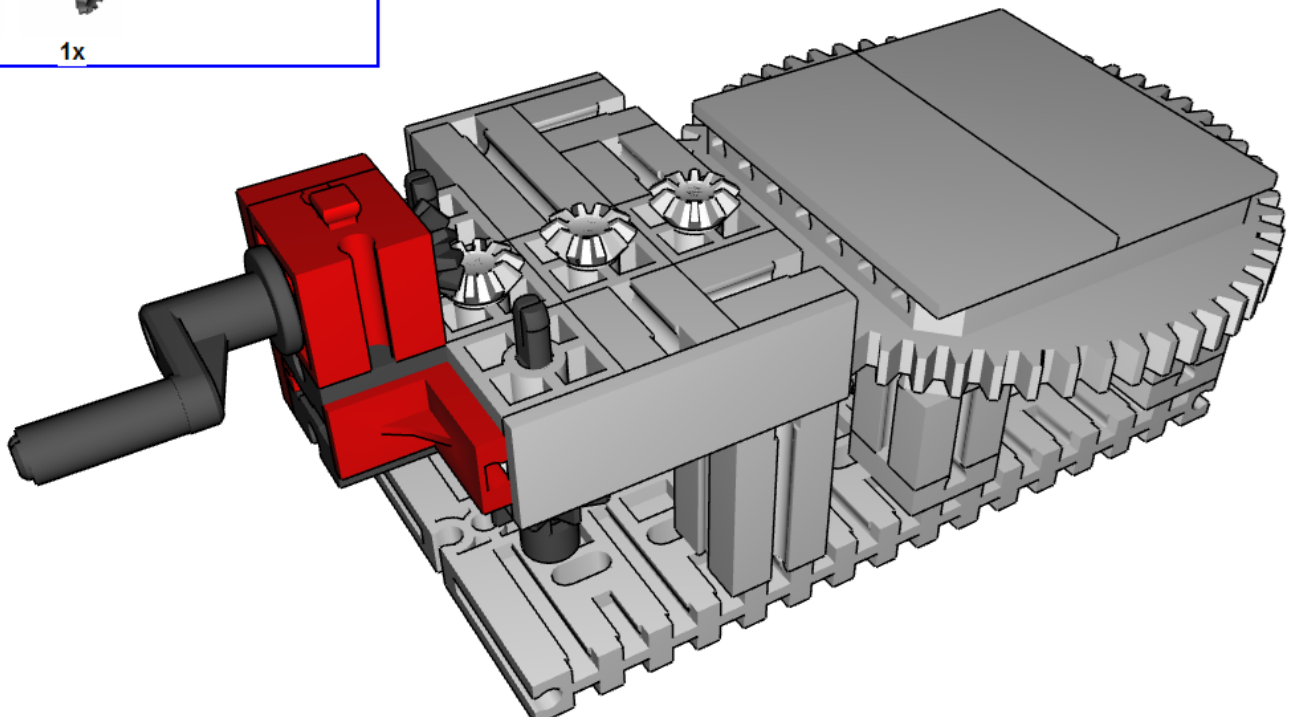



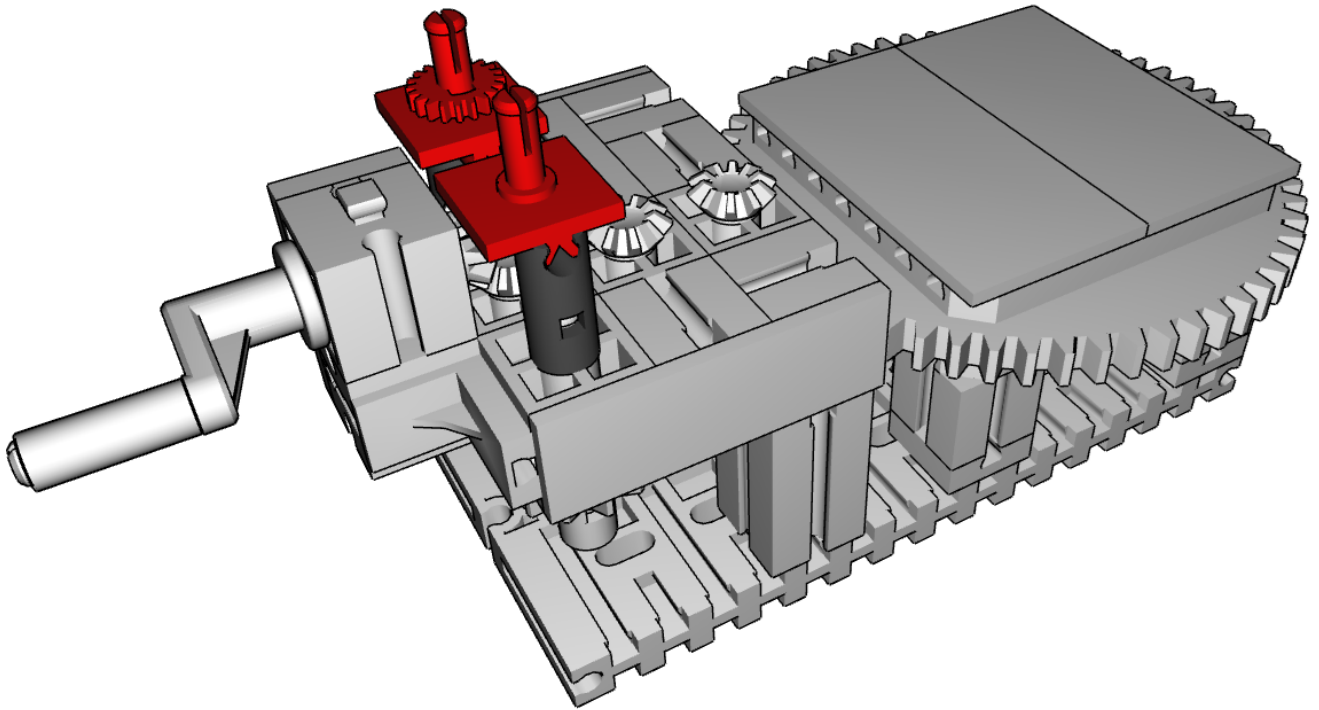
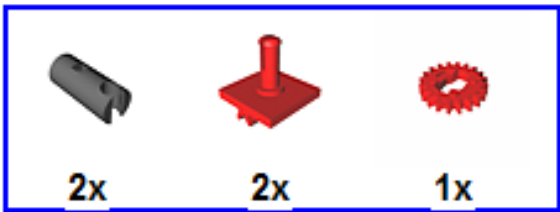

6

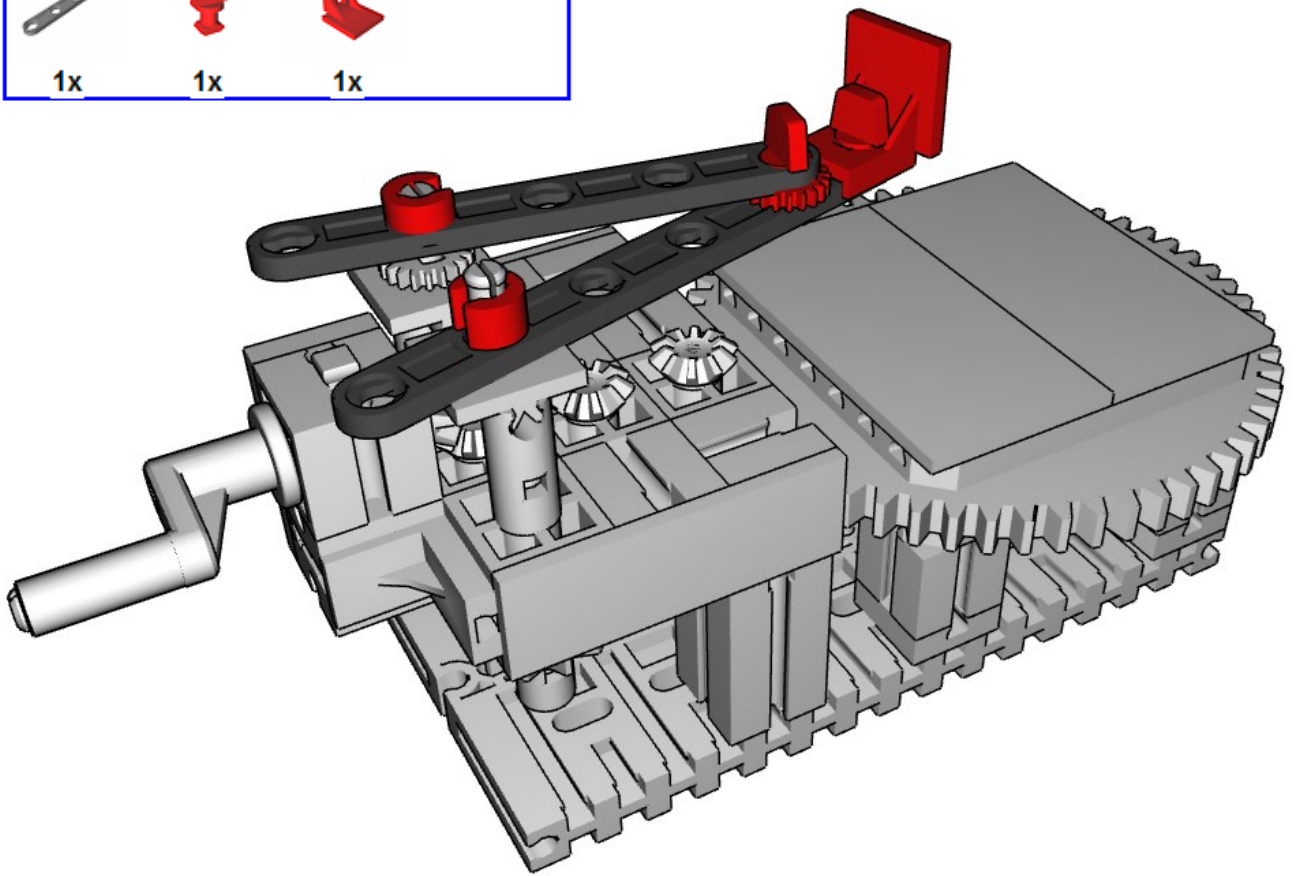
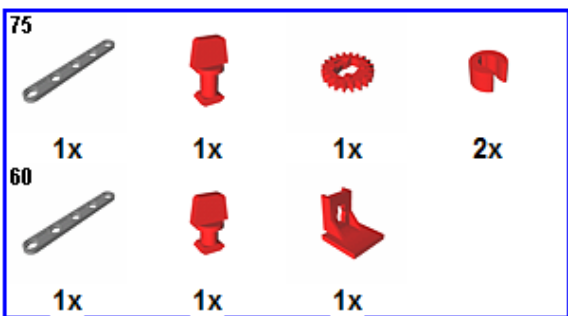

7



1

				
2x	2x	2x	1x	1x

