

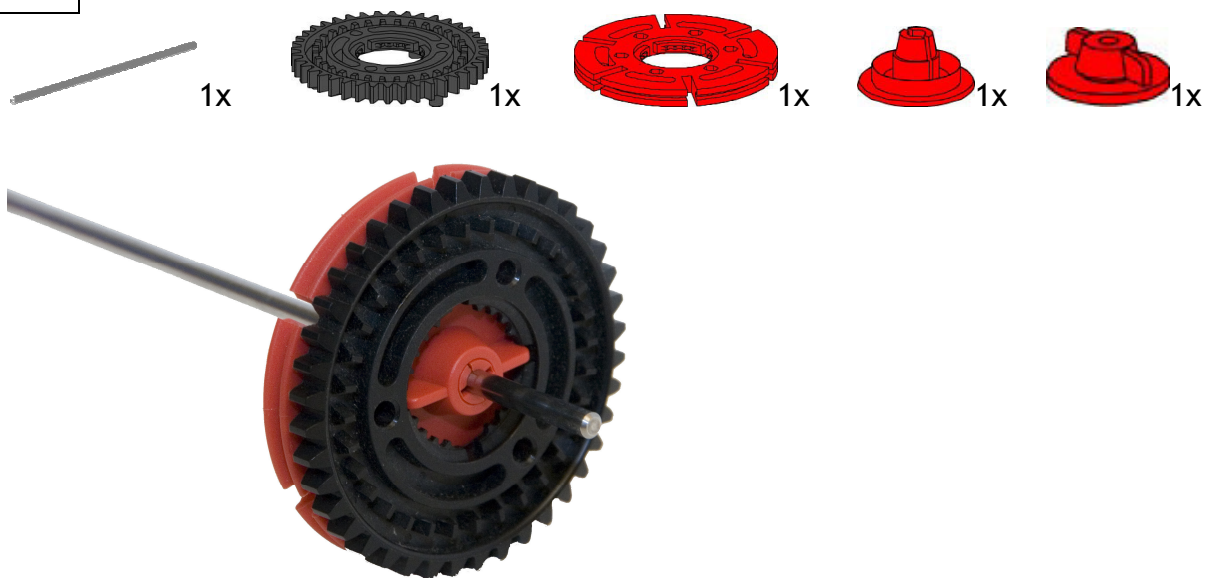

Weihnachtspyramide Teil 2

Christmas Pyramid Part 2- kerstpyramide deel 2
Modell von Thomas004, Anleitung von Masked

10



11

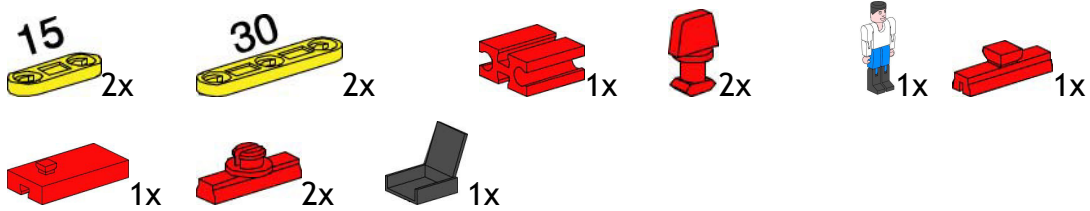

12

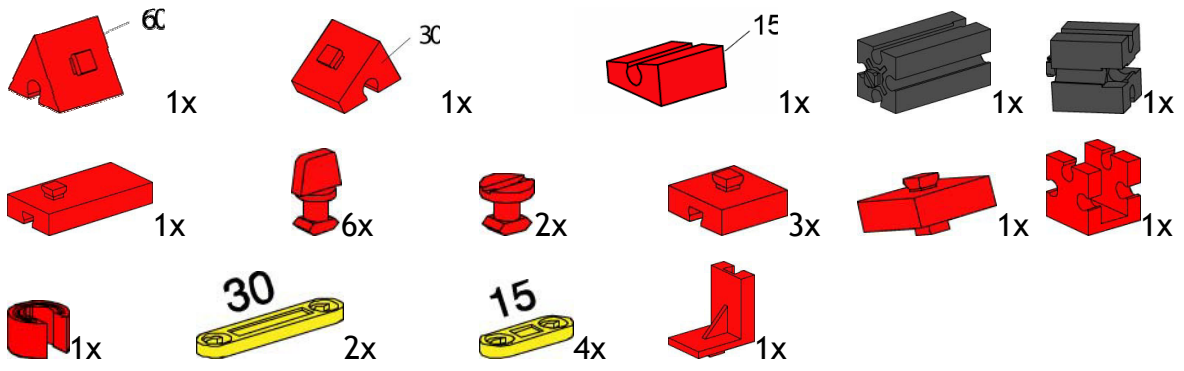

13

6+7+9+10+11+12



14

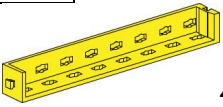

4x

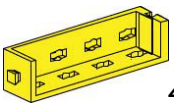

4x

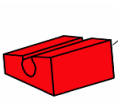

1E

4x

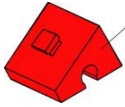

3C

4x

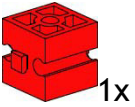

1x



15

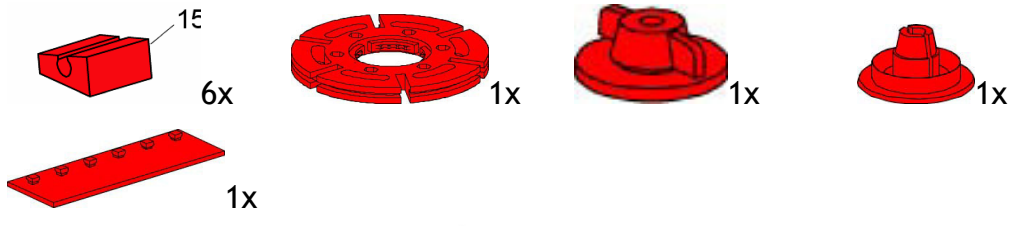

16

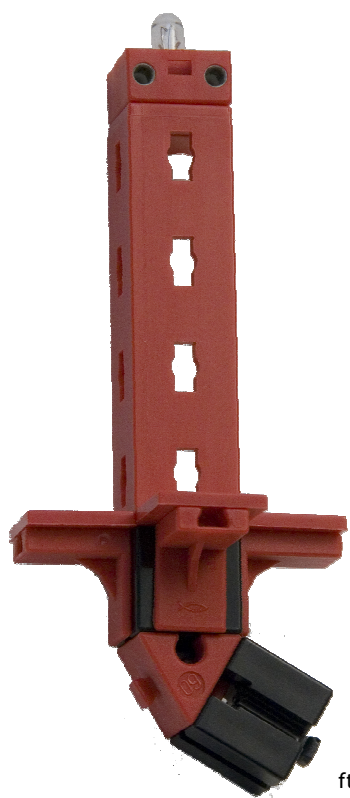
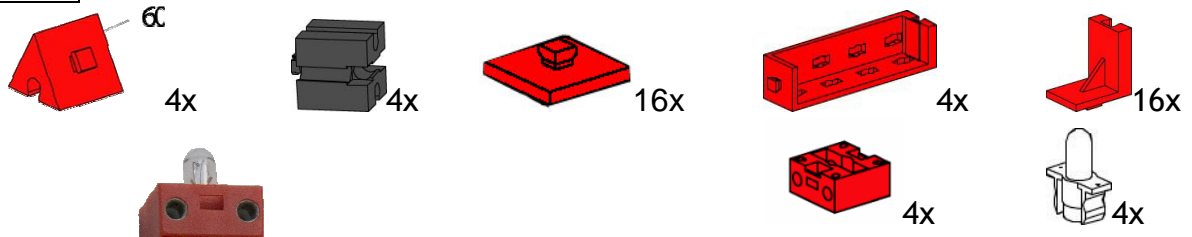

17

14+15+16

+5 Kabel/Cables/cables

+Stromversorgung/Power supply/stroomvoorziening



Frohe Weihnachten

wünscht euch das Team der fischertechnik:community!