



























# Renntier + Schlitten

von thomas004

# Stückliste—Part List - Onderdelenoversicht

	<b>32881</b>
Baustein 15 schwarz	4
	<b>31011</b>
Winkelstein 30 Grad	1
	<b>37636</b>
Rollenlager	1
	<b>32879</b>
Baustein 30 schwarz	2
	<b>31061</b>
Verbindungsstück 30	1
	<b>31981</b>
Winkelstein 15 Grad	3
	<b>38423</b>
Winkelstein 10x15x15	5
	<b>31060</b>
Verbindungsstück 15	2
	<b>31848</b>
Strebenadapter	14
	<b>36913</b>
I-Strebe 45 mit Loch, schwarz	4
	<b>35063</b>
Rastachse 30	2
	<b>37679</b>
Klemmbuchse 5	4

	<b>37232</b>
Verschlussriegel	2
	<b>32859</b>
Bodenplatte 30x90 rot	1
	<b>35668</b>
Radhalter	4
	<b>38545</b>
I-Strebe 75 mit Loch, gelb	2
	<b>36323</b>
S-Riegel 4 rot	4
	<b>38544</b>
I-Strebe 15 gelb	2
	<b>38540</b>
I-Strebe 60 mit Loch, gelb	2
	<b>31982</b>
Federmocken	4
	<b>38428</b>
Bauplatte 15x30x5 mit 3 Nuten	1
	<b>31766</b>
Sitz, schwarz	1
	<b>37468</b>
Baustein 7,5	2
	<b>35060</b>
I-Strebe 120 mit Loch, gelb	2

	<b>36328</b>
I-Strebe 45 gelb	2
	<b>38416</b>
Kunststoffachse 60	1

1

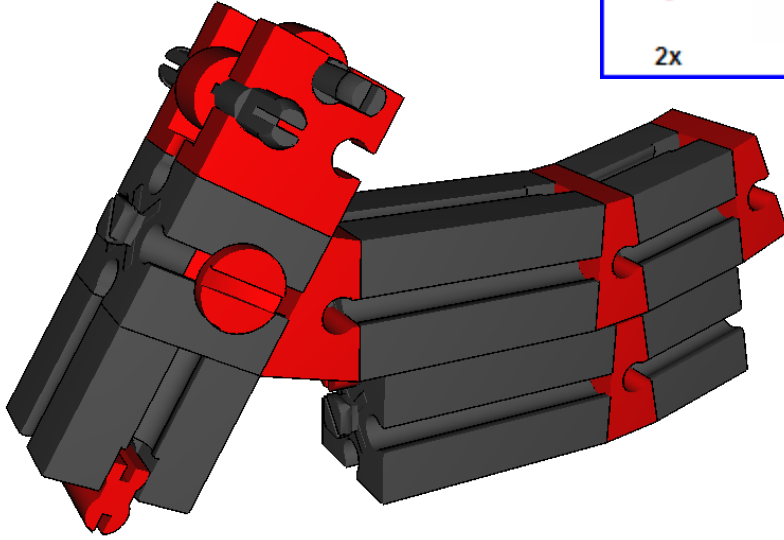
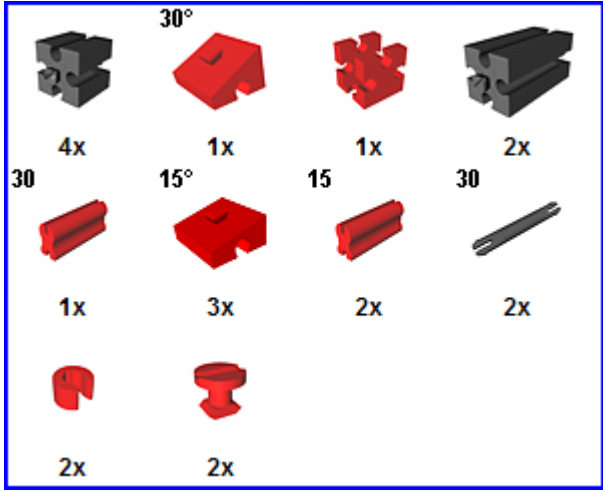

2

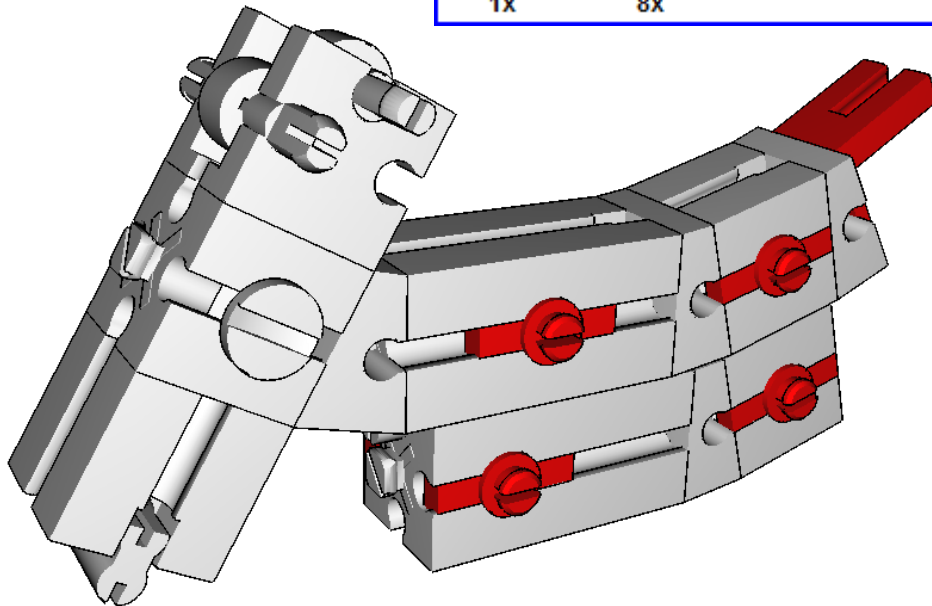

3

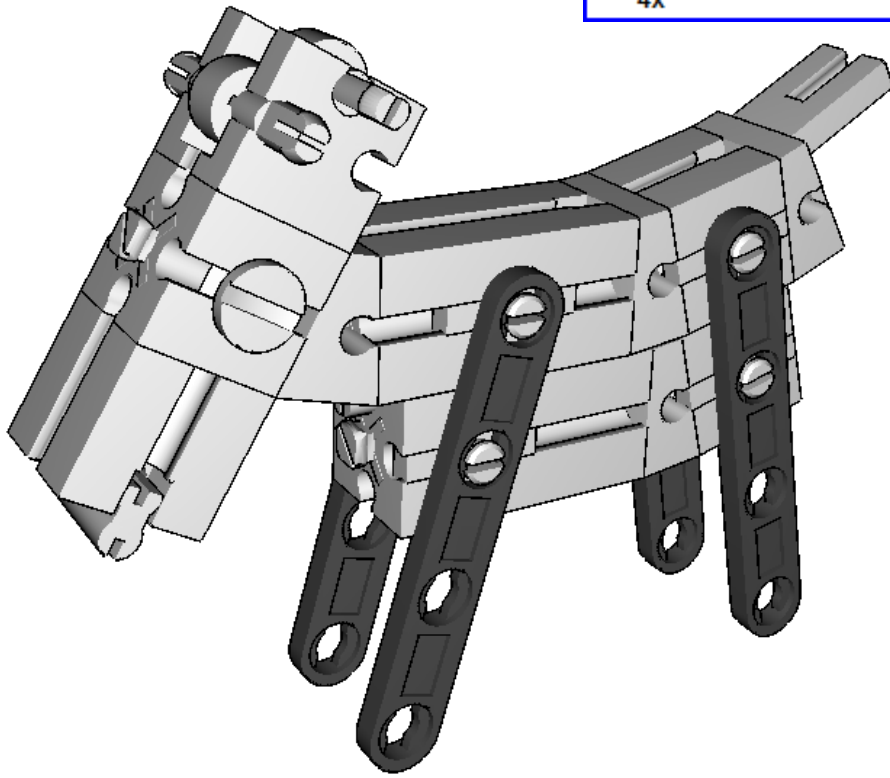

4

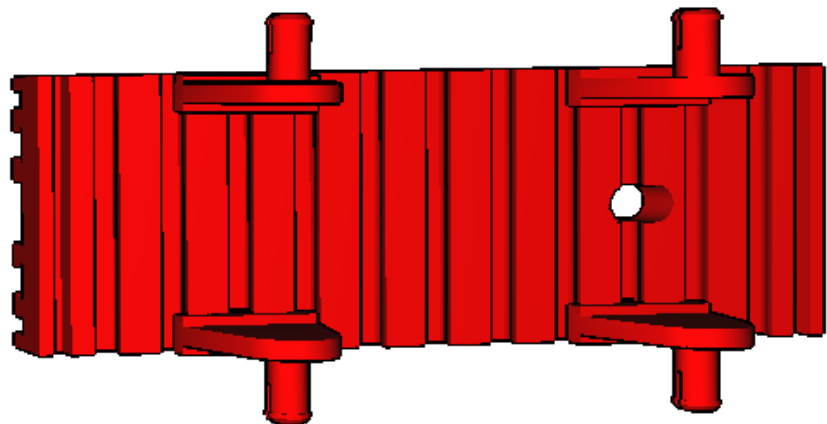



7

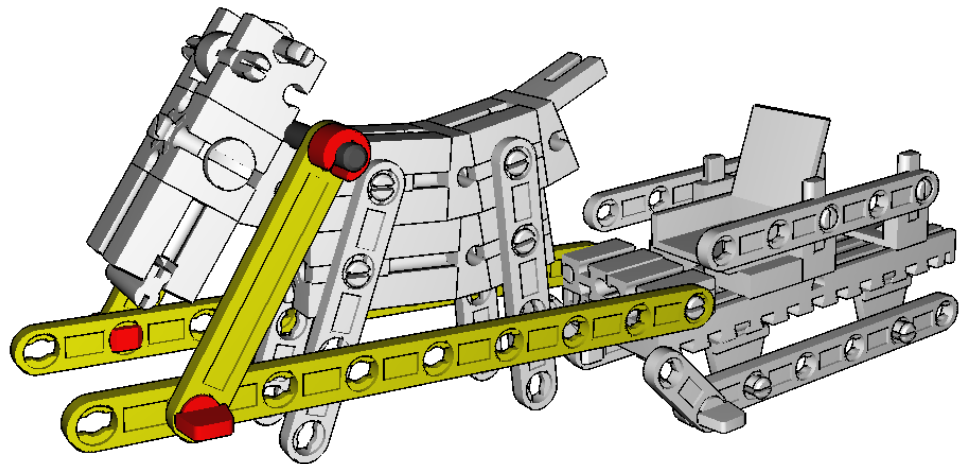
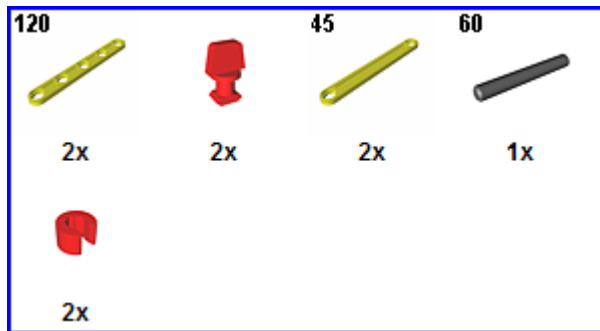

**Hinweis:**

Das Rentier mit dem Schlitten kann auch prima mit dem Swibbogen von Sebastian kombiniert werden. Die Anleitung war ja bereits in einem Türchen enthalten.

Dazu einfach das Rentier mit dem Schlitten unter den Swibbogen stellen!

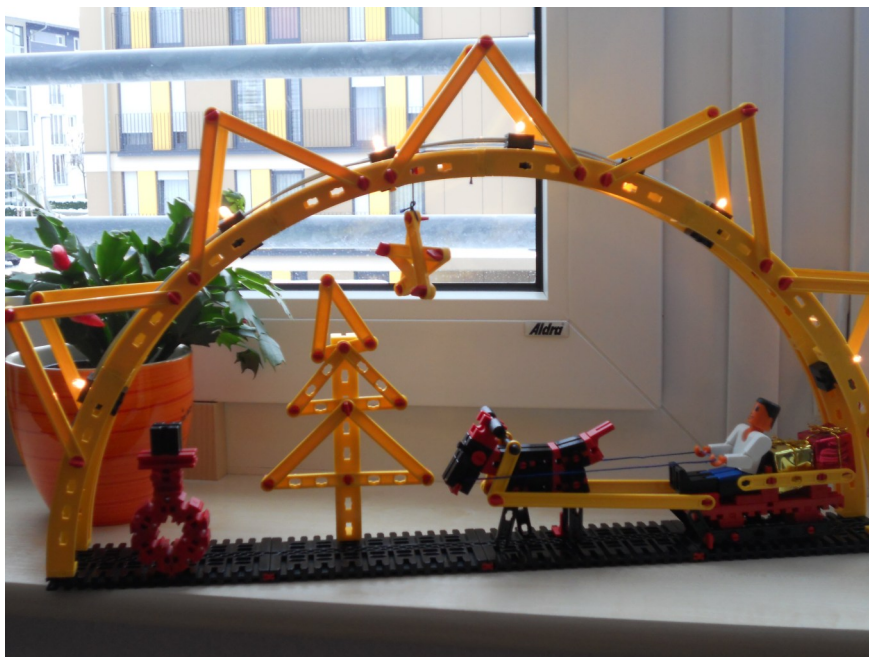

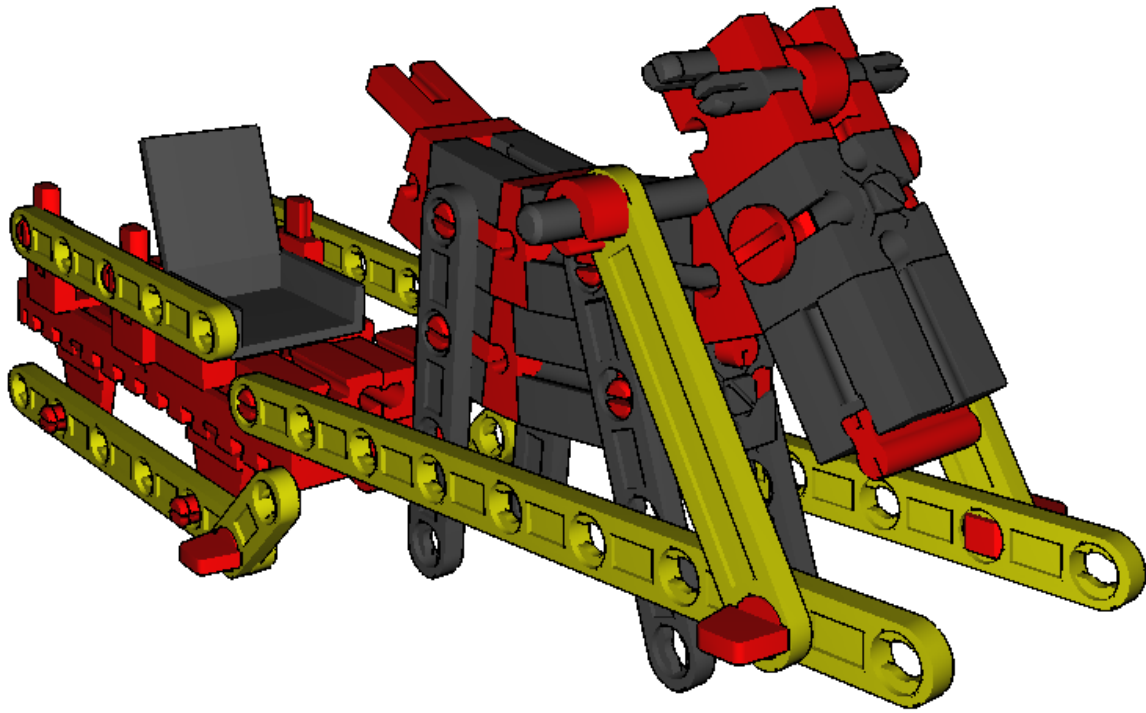

**Frohe Weihnachten**  
wünscht euch das Team der fischertechnik:community!